

High Efficiency And Energy Saving Series - - - Modular Air-Cooled Water Chiller Unit



The Withair System

www.withair.cn

Withair offers a wide range of quality products and solutions to meet the needs of your projects



Ongoing innovation with cutting-edge products



Over 30 years of production experience



Key parts are come from international first-class brands



Guaranteed support and spare parts



Support in design



Documentation for incentives



Five-year guarantee



Free training course

The Withair System

Withair is the premium manufacturer in sustainable energy solutions supplying HVACR products & services for heating, cooling, hot water, indoor air quality, industrial refrigeration, and heat recovery that reflect today's demand for sustainable construction, comfortable indoor climate and industrial cooling & heating process application.

Withair specialises in innovative custom highly-configurable products designed to meet the your needs. We insure products are designed for long life by using highest quality materials, for all controls, safety, and components we only use top world-wide recognized brands. All products are rigorously tested before leaving us, going through many stages of quality control before being shipped.

Withair® has highly effective professional team to service customers

Known for their professionalism and personal integrity, Withair's highly skilled engineers, technicians, electricians, stable manufacturing workers, strict quality controller, and quick-reaction & professional after-service staff utilize their multi-disciplinary expertise in the creation and production of every solution.

Close cooperation among Withair's design, production and service teams - who are located under one roof and linked by advanced computerized systems - enables the Company to supply the widest possible range of products - from single units to very large quantities - while assuring rapid delivery and competitive pricing.



SIMPLY THE BEST SOLUTION AND QUALITY PRODUCT

— HVACR SYSTEMS



Low energy consumption systems
Use of clean energy
Use of environmentally-friendly cooling gases
ZERO direct CO2 emissions in the environment

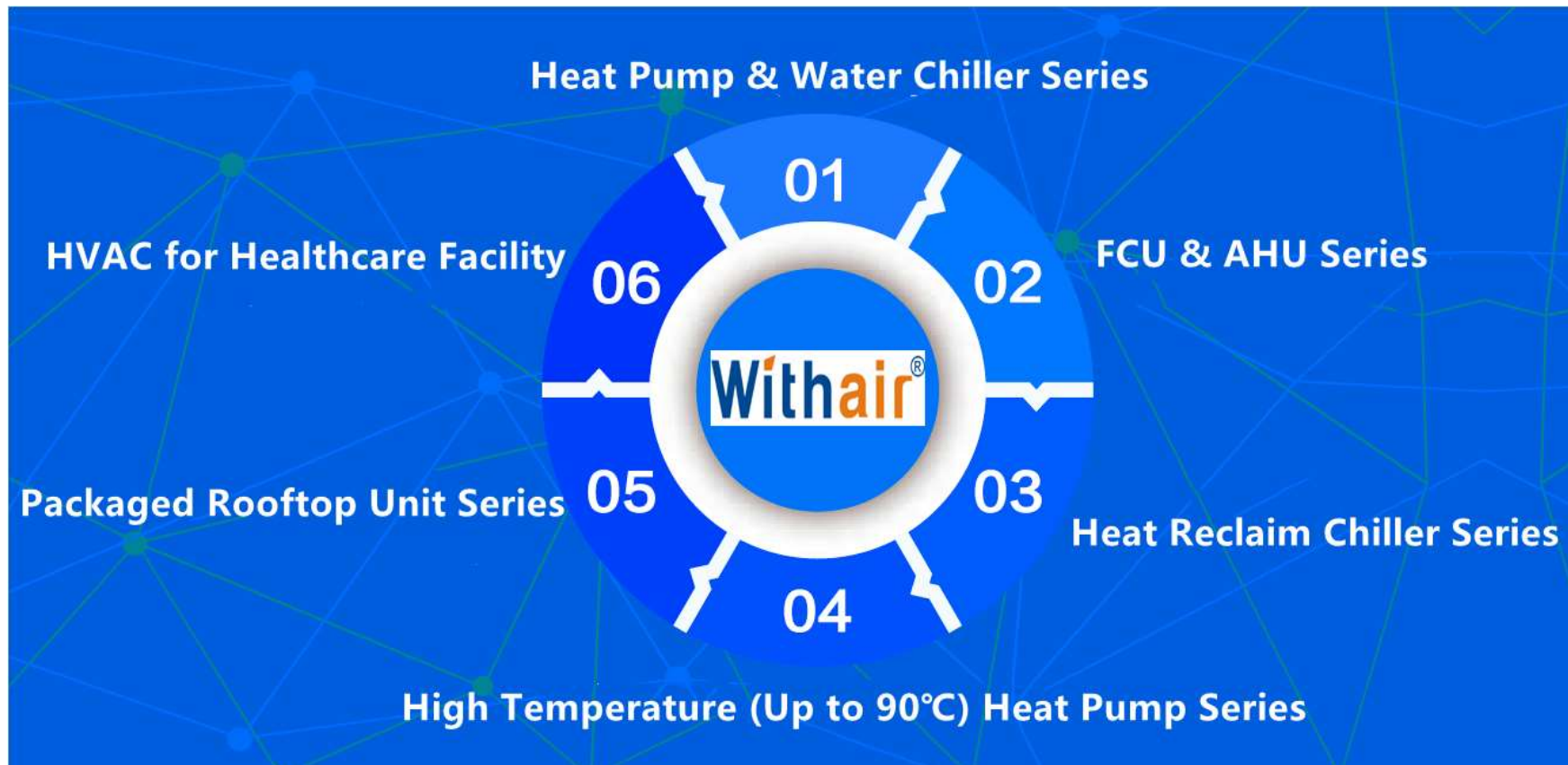

The Withair System

你的家 你的生活

Your home, your life style!



A low-angle, upward-looking photograph of several modern skyscrapers with glass facades, set against a bright blue sky with scattered white clouds. The buildings converge towards the top center of the frame.

*We've a lot of solutions
to care "Construction"*

A photograph of an operating room with a teal color overlay. The room contains a surgical table, various medical monitors, and equipment. A clock is visible on the wall to the right.

*We've a lot of solutions
to care "Hospitals"*



*We've a lot of solutions
to care "Industries"*

A green circular graphic containing text, overlaid on a background of industrial HVAC ductwork.

The Withair System

*Cooling
Heating
Fresh air
Purification
Humidification*

A green horizontal bar at the bottom of the slide containing white text.

*We've a lot of solutions
for "Air Quality"*



Some Production lines



HEAT PUMPS - CREATING A MORE COMFORTABLE & SUSTAINABLE BUILDING ENVIRONMENT

By installing a Withair heat pump, you can reduce your energy consumption costs by up to 86% compared to direct electricity. Here we are using the nature's free and renewable energy sources, such as: outdoor air, geothermal energy, solar energy, that minimises your CO2 emissions and pollution free. You can also enjoy an environmentally friendly, renewable and free energy source. The high level of efficiency means that an investment in a heat pump pays for itself quickly and gives you a secure supply of heat, cool and hot water, suitable for different climate all over the world.

Withair the W01R series heat pumps involve a range of 282 models, with heating and cooling capacity among 2.6kW and 3,200kW, which allow to create "customized" solution, matching the different installations requests.



WATER CHILLERS - MINIMIZE YOUR OPERATING COSTS

Withair chillers were developed based on decades of knowledge and rich experience, includes air-cooled chillers and water-cooled chillers, ranging in capacities from 2 to 3,000+ tons. Withair chillers are relied upon for both comfort and special process cooling applications in every corner of the world.

Withair chiller plays a critical role in creating the right environment to ensure the health, comfort and industrial production. Withair chillers not only serve HVACR systems and industry-type process cooling at factories that deliver the right temperature for the space, but they also help minimize operating costs with superior energy efficiency levels, low sound levels and with minimal environmental impact.



AIR SIDE PRODUCTS - MAXIMIZING HVACR SYSTEM PERFORMANCE

The Withair portfolio of fan coil unit, ventilation unit and air handling unit, air cooler solutions is designed to make installations faster and easier, offers temperature and humidity control, heat recovery, deodorization, air purification, and heat treatment, and to maximize HVACR system performance. Using advanced technology, such as: EC motor, single-zone, four-pipes, these systems quietly, temperature stability, reliably and efficiently deliver the comfort your building occupants need.



Withair offers a full range of air side products and systems to meet your performance requirements. From 200CFM to the highly flexible 60,000CFM with numerous custom options, to a completely custom, energy efficient, environmentally responsible system, Withair has the optimal solution for commercial, industrial and process applications.

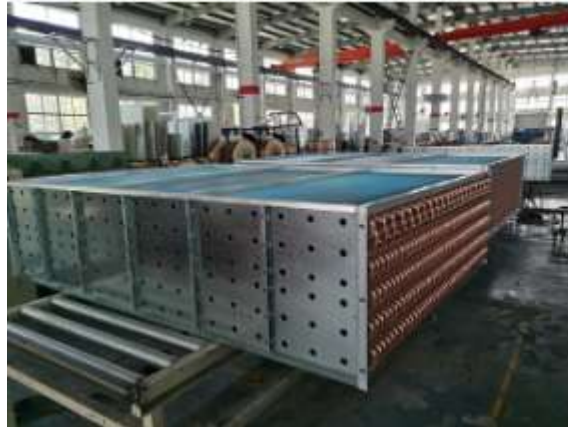

INNOVATIVE PRODUCTS - THE MOST EFFICIENCY SOLUTION

Withair has developed different innovative products, e.g. Fresh Air Heat Pumps, Rooftop HVAC Unit(RTU), Make Up Air Unit(MUA), 100% Outdoor Air Unit(OAU), Clean Air Conditioning, Ultra-high Temperature Heat Pump, Hybrid Heat Pump, ..., these products meet the needs of different applications for heating & cooling and indoor air quality.

Whether you want to replace an existing air conditioning or heat pump – or reduce your energy costs with a Hybrid Heating and Cooling Solution – our products could be the creative solution you’re looking for. By combining multiple types of energy into a single unit that sits outside your home, the only thing left inside is improved comfort.

Withair® devote to a variety of energy comprehensive utilization, optimize configuration of all kinds energy, complementary advantages, offer hybrid energy system integration solutions, and maximizes efficiency and energy savings.



Big Size Modular Air-Cooled Water Chiller Unit



Big Size Modular Air-Cooled Heat Recovery Chiller



DIRECTORY

PRODUCT NOMENCLATURE	18
PRODUCT DESCRIPTION	19
THE KEY ADVANTAGES INCLUDE	33
SPECIFICATIONS	52
ELECTRIC DIAGRAM	60
SYSTEM SCHEMATIC DIAGRAM	64
POWER CONNECTION	65
INSTALLATION NOTES	66
UNIT HOISTING	72
PROJECTS SOLUTIONS	73
DELIVERY & PACKAGING.....	77
TECHNICAL SUPPORT	78
ON LINE PRODUCTION & INSTALLATION CASE	79
SOME CERTIFICATES	88

PRODUCT NOMENCLATURE

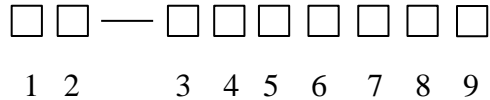

Digit 1. W: Withair brand

Digit 2. 02: series number

Digit 3. C1: air-cooled chiller, C2: water cooled heat pump, Rd: electric auxiliary type

Digit 4. Specification code

Digit 5. PH: partial heat recovery, TH: total heat recovery

Digit 6. Fixed frequency compressor: default, I: inverter compressor

Digit 7. R1: R410A, R2: R407C, R3: R134a, R22: default

Digit 8. X: design code

Digit 9. V1a: 220V/1Ph/50Hz, V1b: 220V/1Ph/60Hz, V1c: 115V/1Ph/60Hz

V2a: 380V/3Ph/50Hz, V2b: 380V/3Ph/60Hz, V2c: 230V/3Ph/60Hz

V3a: 440V/3Ph/60Hz, V2b: 575V/3Ph/60Hz

—— Product Description ——

Withair® Air-Cooled Water Chiller Unit is a very intelligent chiller system with flexible capacity output. It could adjust cooling capacity output automatically according to requirements. It is much more energy-saving with a long lifespan.

Withair® Air-Cooled Water Chiller Unit is a kind of central air conditioner which adopts air as the cooling source and water as cooling medium. With rich experience in R&D, design and application, Withair® constantly launched new environment-friendly modular units, which improves the structures, systems and programs based on original products, and designs special series of comfortable and technological units. The environment-friendly modular unit has complete functions and various specifications, with basic modules of any combination available for different models. Withair® offer quiet, reliable, energy efficient equipment. These units incorporate high quality compressors, state-of-the-art coil design, and innovative packaging. As a sort of integrated equipment, it needs no cooling tower, cooling water pump, boiler and corresponding auxiliary parts, which makes the system more simple, saves installation space, convenient maintenance and energy saving, thus it is very suitable for areas that are short of water. several modules can be formed in to a air-cooled chiller module unit by connecting each module's inlet & outlet pipeline in parallel. with a system without cooling water, with simple pipelines, moderate cost, short construction period, allowing staged investment, the whole unit consists of 1~16 modules and the maximum capacity is 9,040kW.

Withair® Air-Cooled Water Chiller Unit can be widely applied to civilian projects and industrial projects, such as hotel, villa, restaurant, hospital, factory, etc. it is a wise choice for areas where water is insufficient or there are strict limits on noise level and surroundings. Each unit is verified for total unit performance before shipping to insure quality standards are inherent in every unit.

Unit adopts modular design, relatively independent modules units can be any combination and through microcomputer for centralized control, unit according to the change of load start-stop corresponding number of module unit to adjust the supply of cold capacity, to achieve the goal of high efficiency and energy saving. With FCU, VAV and AHU and fresh air units, semi-central air conditioning system has the flexible layout, beautiful shape, saving space, convenient adjustment, low running noise, etc.

R410A CLASSICAL MODULAR UNIT

The new generation environment-friendly modular air-cooled unit is based on years of experience in R&D and design, which is greatly improved in aspects of the structure, system and microcomputer control technology, providing wider operation range of refrigeration and heating, and higher adaptability to applications with requirements on comfort and technology. There are basic modules of any combination available for different models, including 68kW, 102kW, 136kW, and at most 16 modules can be connected in parallel, providing combination products of 68kW~3200kW.

— Excellent Capacity —

Units of the same model or different models can be combined freely. Each group can combine up to 16 modules.



— Intelligent Defrosting Technology, Non-stop When Defrosting —

The unit control system can determine whether defrosting is necessary according to the ambient temperature in heating mode, evaporating temperature and running time; when defrosting conditions are met, the unit will automatically activate the defrosting program to complete defrosting within a short time and provide heating operation efficiency up to over 90% , ensuring the optimum heating capacity and high COP.

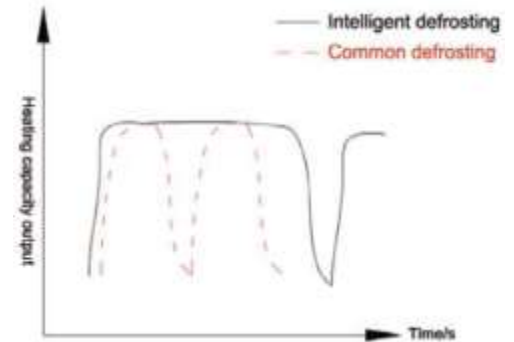

— Free Master Module Design —

Any single unit can operate as the master once connected with the wired controller. It overcomes the problem that the whole system would fail to work properly when the fixed master unit malfunctions.

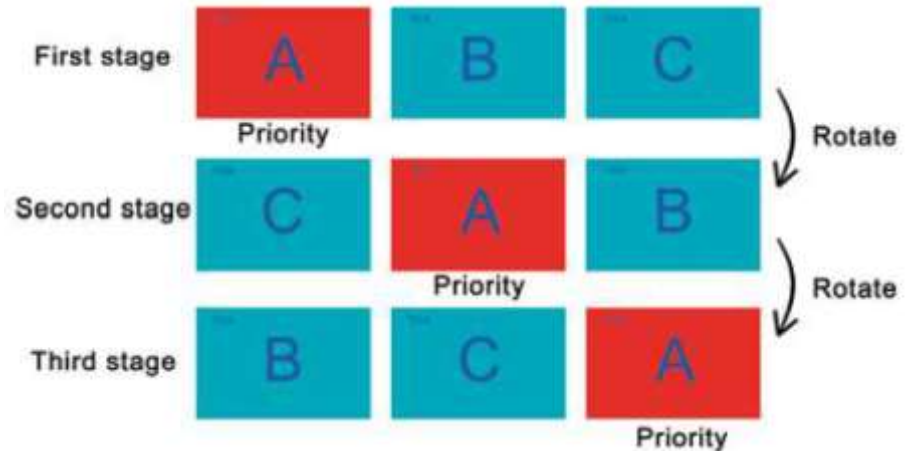

—— Intelligent Air Volume Management ——

The shared duct system is adopted to greatly expand the operating range. The single-module unit can automatically increase or reduce fans based on the ambient temperature to achieve optimal matching between air volume and load and deliver outstanding performance.



—— Intelligent Energy Management Technology ——

The Unique intelligent energy regulation technology in multi-module combination ensures that each module loads or unloads a refrigerant circuit before loading or unloading other refrigerant circuits in the single module, thereby providing higher efficiency, stability and IPLV.



— Widely Operation Range —

Low temperature cooling

5°C ~ 48°C

High temperature heating

-15°C ~ 48°C

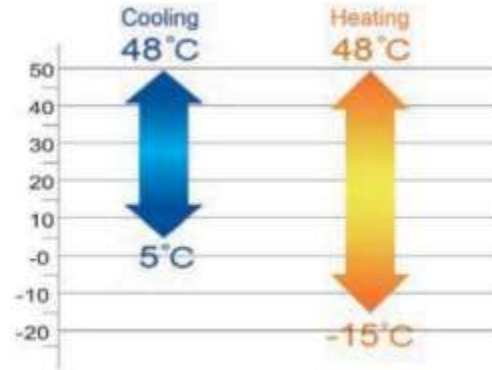

— Compact Design And Smaller Footprint —

Unique and compact structure results in small size and occupied area, significant reductions in installation space and cost; the unit is compact and easy to install. A 136kW unit covers floor space of only 2.4m², a 50% reduction compared to its equivalents.



— Reliable Hermetic Scroll Compressor —

Unit adopt reliable hermetic scroll compressor, which is high efficient, energy saving and operates stably, with low noise, slight vibration and long service life.

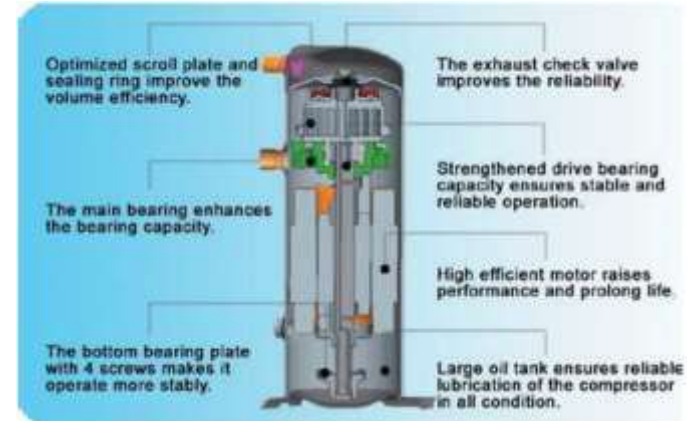

— V-Shaped Condenser —

The V-shaped condenser has used condenser has used an integral reinforcing metal frame, internal thread and tripe anti-frosting features (patented design of open-window hydrophilic aluminum foil + bottom elevated + one-way valve), providing higher structural stability and corrosion resistance; with heat exchange efficiency improved through full use of heat exchange area, low tendency to dust accumulation and frosting in winter, low loss of pressure, smoother drainage and higher reliability.

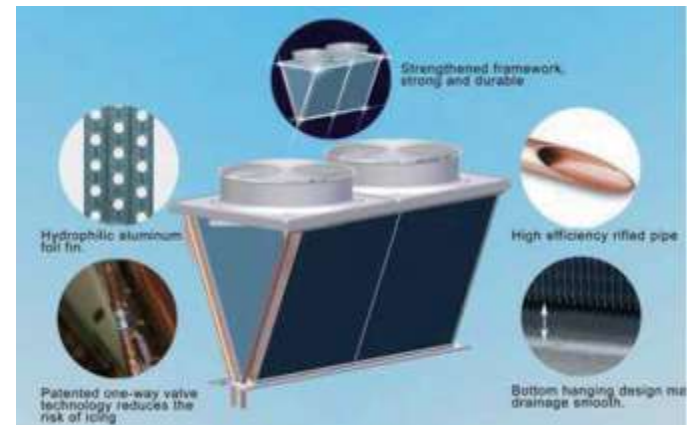

— Efficient Shell And Tube Heat Exchanger —

The waterside efficient shell and internal thread heat exchanger is of helical baffle type, with better heat transfer performance and higher resistance to freezing than plate heat exchanger, lower water resistance and lower requirements for water quality.

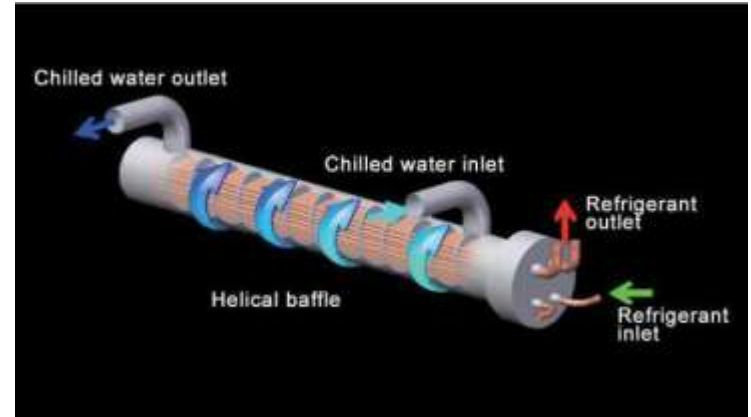

— Saw-shaped Condenser Fan Blades —

Compared to plastic impellers, the saw-shaped condenser fan blade provide large air volume, high durability and high air supply efficiency with low noise.

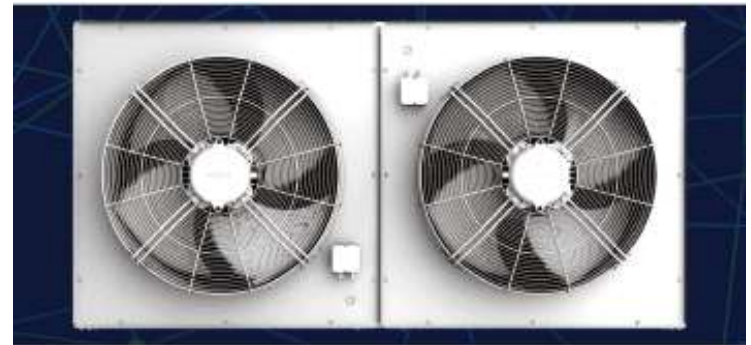

—— High Precision Electronic Expansion Valve ——

The electronic expansion valve achieves 480 regulating range, supplemented by Withair's patented precision throttle control technology to realize dynamic matching in refrigerating system, fully improve the optimum efficiency of each component and ensure the optimum condition of system operation pressure and temperature.

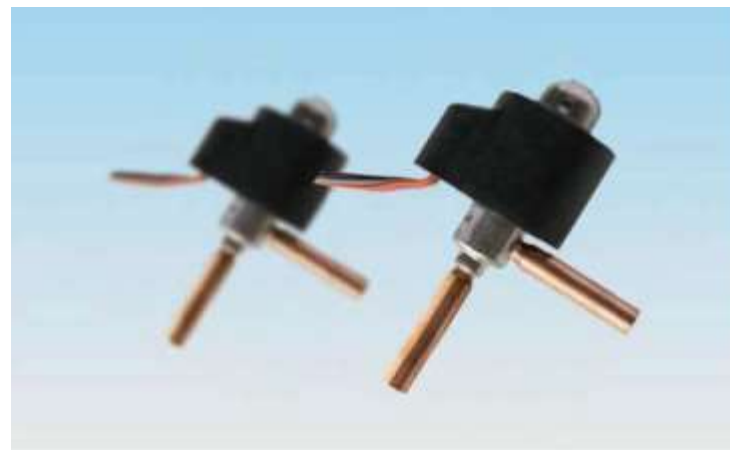

—— New R410A Environment-friendly Refrigerant ——

R410A environment-friendly refrigerant does not contain chlorine which destroys the ozone layer, and the ozone layer destruction system (ODP) is zero. At the same time, it effectively reduces CO2 emission, has stronger anti-low temperature ability and higher cooling efficiency.



— In House Engineered Microprocessor Control —

The Withair control panel is fully upgraded based on origin control panels with years of experience in R&D and design, which combines more functions including phase sequence detection, current detection, RS-485 communication interface, delivering stronger performance, utility, standardization, convenience and universality. The USB interface is so provided to facilitate later-stage maintenance and upgrade of control function. The panel is supplemented by Withair developed control program which offers full operation control and multiple safety protection functions.



— Multiple Protection Functions, Providing Safety And Reliable —

The unit has multiple safety protection functions which ensure safety and stable operation of the unit and systems.

The water flow switch and multiple anti-freezing program designs protect the unit and systems in an all-round way.

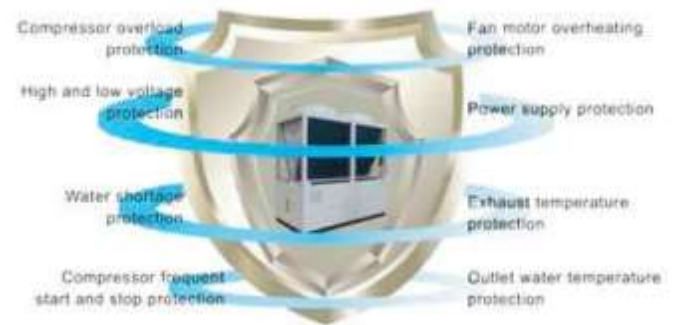

Super Protection Function To Ensure The Safety Of System Operation

The unit is equipped with a fully functional protection module, with the industry's most complete 13 kinds of safety protection functions and powerful fault diagnosis function as follows:

- Power phase loss, reverse phase protection;
- Current overload protection;
- Insufficient water flow protection;
- Frost protection;
- Pump overload protection;
- Water pump linkage protection;
- Fan motor overload protection;
- Compressor exhaust pressure is too high protection;
- Compressor return air pressure is too low protection;
- Compressor exhaust temperature is too high protection;
- Compressor intelligent scroll temperature protection;
- Cooling operation cooling water temperature is too low protection;
- Overheating protection of cooling water temperature in heating operation;



—— **New Touch-wire Controller, Easy To Control The System** ——

A set of wire controller can meet up to 16 modules parallel at the same time to achieve centralized control, and users can know the operation and fault state of the unit through the wire controller in time.

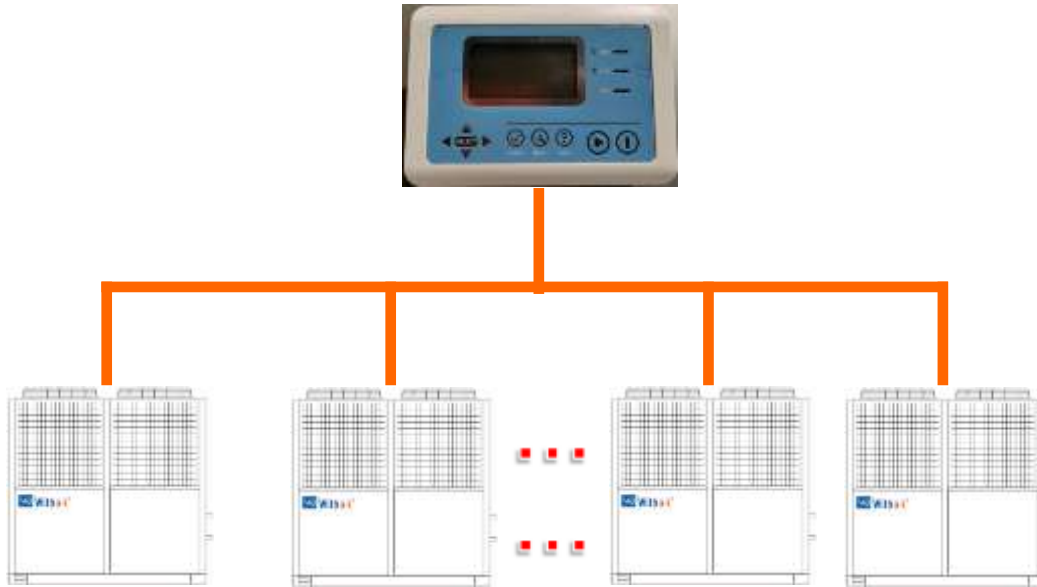

— Ultra-low Temperature And Wide Temperature Working Conditions Operation —

The reliable operating range of Withair series module unit is $-26^{\circ}\text{C}\sim 48^{\circ}\text{C}$, when ambient temperature at -26°C , unit still can be strong heating, which can realize the stable operation under the wide temperature range of $-26^{\circ}\text{C}\sim 48^{\circ}\text{C}$.



R410A HEAT RECOVERY MODULAR UNIT

Withair's heat recovery modular air-cooled chiller unit uses the environment-friendly refrigerant R410A and combines the features of Withair's air-cooled chiller and air-source heat pump water heater unit. It has two modes: A/C cooling, A/C cooling + heat pump water heating, widely applied in places requiring central air conditioning and water heating, such as: hotels, schools, restaurants, hospitals, villas, bath centers and industry use.

—— Free Domestic Hot Water ——

In the A/C cooling mode, the unit can recover waste heat and provide free domestic hot water to 55°C. The unit replaces the boiler to meet the user needs for hot water, saves initial investment, eliminates the need for machine room, and saves the building area and energy for environmental protection.



—— Less Occupied Area ——

A single module covers a floor area of only 1.86m² which is the smallest in the industry, leaving larger valuable space for customers. The unit can substitute the boiler, eliminates the need for machine room, and saves initial investment and building area.



— **Compact Design And Complete Functions** —

In the A/C cooling mode, the unit can recover waste heat and provide free domestic hot water to 55°C. The unit replaces the boiler to meet the user needs for hot water, saves initial investment, eliminates the need for machine room, and saves the building area and energy for environmental protection.



— **Efficient Components Providing Higher Efficiency** —

The unit employs efficient shell and tube heat exchanger, fan, and heat recovery unit, with optimized pipeline design, providing comprehensive energy efficiency up to 8.24 under conditions of cooling + heat recovery.



— The Key Advantages Include —

- ECO friendly refrigerant R410a, R407c.
- Flexible configurations with top or side piping and front or side control box.
- Large panels for accessibility to compressor and controls sections
- Plate type, coaxial tube-in-tube heat exchanger for high performance, reliability, and resistance to freezing.
- Multi-function: provide cooling only, cooling with hot water, partial heat recovery for domestic hot water heating (55°C).
- Unit choose efficient rotary or scroll compressor, the use of high efficient heat exchanger technology processing, condensation temperature greatly reduced.
- When multiple units were combined into a system, because each unit can be individually ON/OFF; wide range of system energy regulation and running costs fell by more 40%.
- Unique compressor anti-vibration technology (patent ZL 2020 2 0246589.1) and sound attenuation material ensure ultra-quiet performance.
- Advanced microcomputer automatic control system, with protection of high and low pressure, overload, low voltage, phase lack, and low temperature etc., with terminal for the external pumps, and displays and alarms malfunction.
- Running ambient range from -20°C to 50°C.
- Built-in hydraulic module for option.

—— The Key Advantages Include ——

- Multi-system design and wear-and-tear management technology reduces electric impulse and extend service life.
- Modular network function: unit control system is equipped with the network communication, the user can control operating units quantity according to the actual use load, make user side water system utilities, to realize the automatic device management automation and energy management.
- Smart microchip control and large LCD user interface, capable of one-key startup.
- Automatic intelligent reset. Unit shall automatically restart 5 minutes after shutdown if the fault has cleared. Should a fault occur 3 times sequentially, then lockout will occur.
- Humanized design, widened application scope: the unit's temperature settings for room, hot water, water intake/outlet, freeze protection, and compressor exhaust can be adjusted on-site according to environmental conditions.
- Communication adapter connection the unit to BMS(Building Management System) is an optional accessory, please get in touch with us or our distributor if required.
- Unit with multi-protection to guarantee the unit running stability and security, such as: high/low voltage, low oil level protection, exhaust temperature, antifreeze, power lack/reverse phase, water system cut off. operating condition with small change range stable operation, safe, reliable and long service life.
- Easy installation, simple water piping system configuration, you can make design partition and divide second installation.

—— The Key Advantages Include ——

- **Quality components selection**

Compressors and refrigeration accessories (such as dry filter, thermal expansion valve, liquid supply solenoid, liquid level mirror, high/low pressure control devices) all chosen world-renowned brand products to ensure that the unit reached an excellent level of performance. Using the most advanced DAE / DAC efficient heat transfer pipe, heat transfer surface with internal ribbed tube makes the heat transfer coefficient substantially increased; the heat exchanger unique structural design, the best way of copper tube layout and precision of refrigerant control technology, greatly improved the efficiency of heat transfer.

- **Perfect control**

- 1) Computerized control with standby manual operation system
- 2) Compressor Operation timing
- 3) Compressor automatic start-up sequence,
- 4) Alarm signals
- 5) Alarm reset
- 6) Water temperature control
- 7) Manual reset high pressure switch, Automatic reset low pressure switch

- **Equipped self-diagnosis function, and automatically eliminate software problem**

—— **The Key Advantages Include** ——

● Protections that ensure its safe and stable operation:

- 1) Reverse phase
- 2) Lack phase
- 3) High/low pressure
- 4) Gas discharge
- 5) Outlet water temperature too low (high)
- 6) Water stopped
- 7) Antifreeze
- 8) Compressor overheat etc.

● All the components covered with casing, keeps damages to cooling and electrical system away.

● Small size, light weight, easy for installation, transfer and maintenance, can be put into use just make water pipes and the power supply cable be connected at the site.

● EVI compressor as option. EVI compressor-enhanced vapor injection, Vapor-injected method can effectively improve heat capacity, prevent higher discharge temperature of compressor and guarantee operating stability of unit at low temperature).

— Features —

● **STRUCTURE**

Panels and frame are made from galvanized steel protected with polyester powder painting to ensure total resistance to atmospheric agents.

● **HERMETIC SCROLL COMPRESSORS**

Single phase type and 3-phase scroll type compressors, with built-in thermal overload cut-out and crankcase heater, mounted on rubber vibration dampers.

● **EVAPORATOR & CONDENSER**

High efficiency plate type heat exchanger, tube in tube heat exchanger, shell and tube heat exchanger, factory-insulated with flexible close cell material.

● **REFRIGERANT CIRCUIT**

Copper tube connection with charge valves, filter, thermostatic expansion valve, gas-liquid separator, high pressure switch and low pressure switch. The heat pump units are complete also with 4-way valve and one way valve.

● **HYDRAULIC CIRCUIT**

No build in water circuit as standard.

● **ELECTRIC PANEL**

Consists of: Compressor contactor, Compressor protection breaker, Microprocessor with function display.

● **OPTIONAL PARTS**

- Source side water flow switch, source side water pump, & user side water flow switch, user side water pump, hot water pump
- Expansion tank
- Metallic filter for the water circuit
- Build in water circuit
- Modular type
- Heat recovery for domestic hot water (55°C)

High efficiency scroll compressor

The most advanced enclosed scroll compressor, high efficiency, low noise, low tremble and high coefficient.

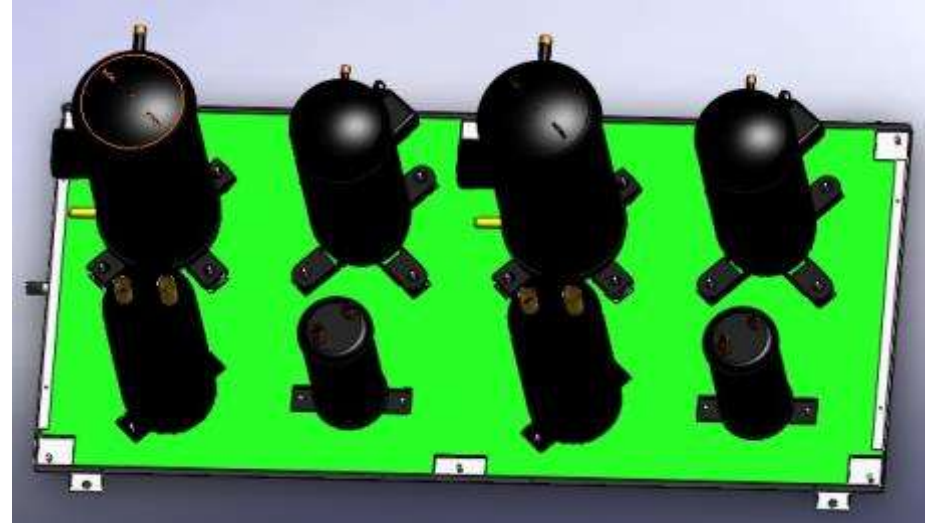
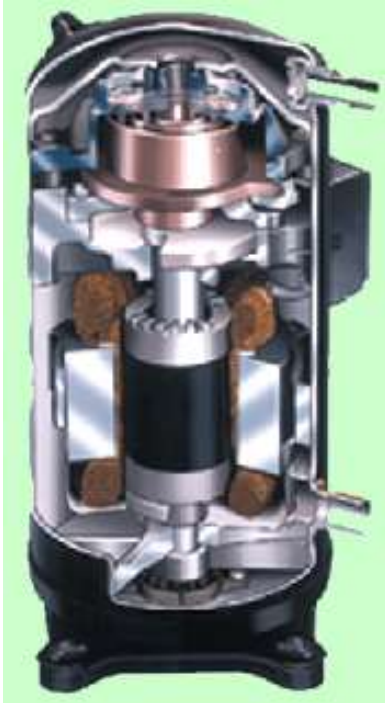

Multi-system and Modular combination of compressors maximally reduce energy consumption

High efficiency condenser

- *High-efficiency Seamless inner groove copper tube.*
- *Mechanically expanded onto the die formed aluminum fin.*
- *Units adopt hydrophilic and antiseptic aluminum foil, could adapt wicked weather conditions*



Units adopt “V” type lateral heat exchanger and unique patent protection(Patent No. ZL 2010 2 0243062.2) technology of heat exchanger, realize high heat transfer efficiency and the whole heat exchange rate is higher than common heat exchanger by 30%.

High Efficiency Evaporator

Water side heat-exchanger

- Shell and tube type, copper tube
- DX without any oil return problem
- Internally-finned copper tubes
- 20 mm insulation cotton

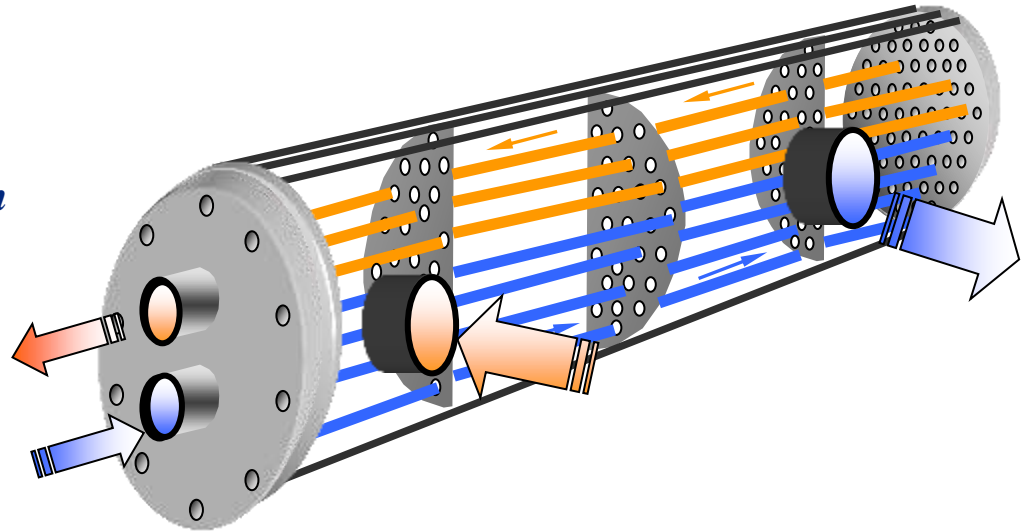

Fan Motor



- *Big airflow and static pressure.*
- *Static and dynamic balanced fan with low noise and vibration.*
- *High efficiency fan motor. Direct drive type, 6-pole, 3-phase, Class-“F” insulation and IP54 protection.*

Refrigerant flow control

- *Electronic-expansion valve*
- *High precise control*
- *Real PID modulation*

(PID Means Proportion Integration Differentiation)

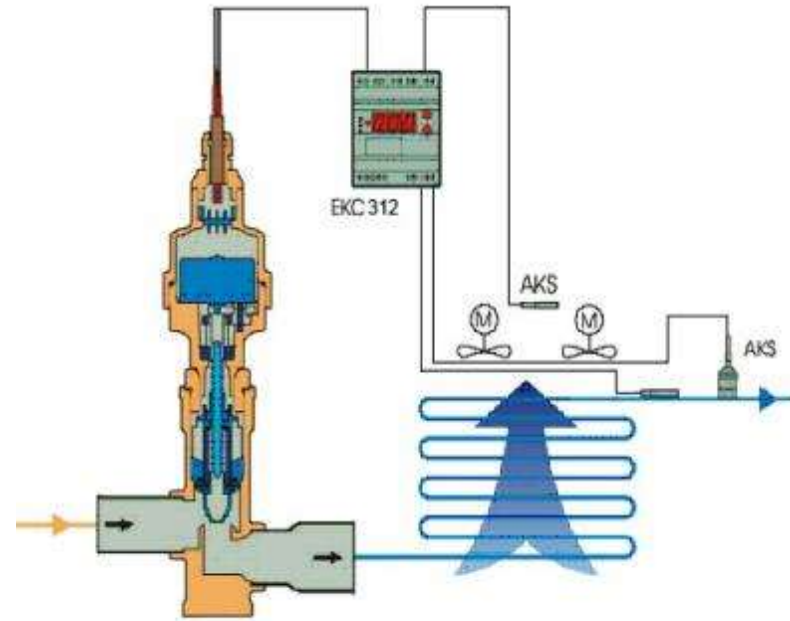

Electrical control system

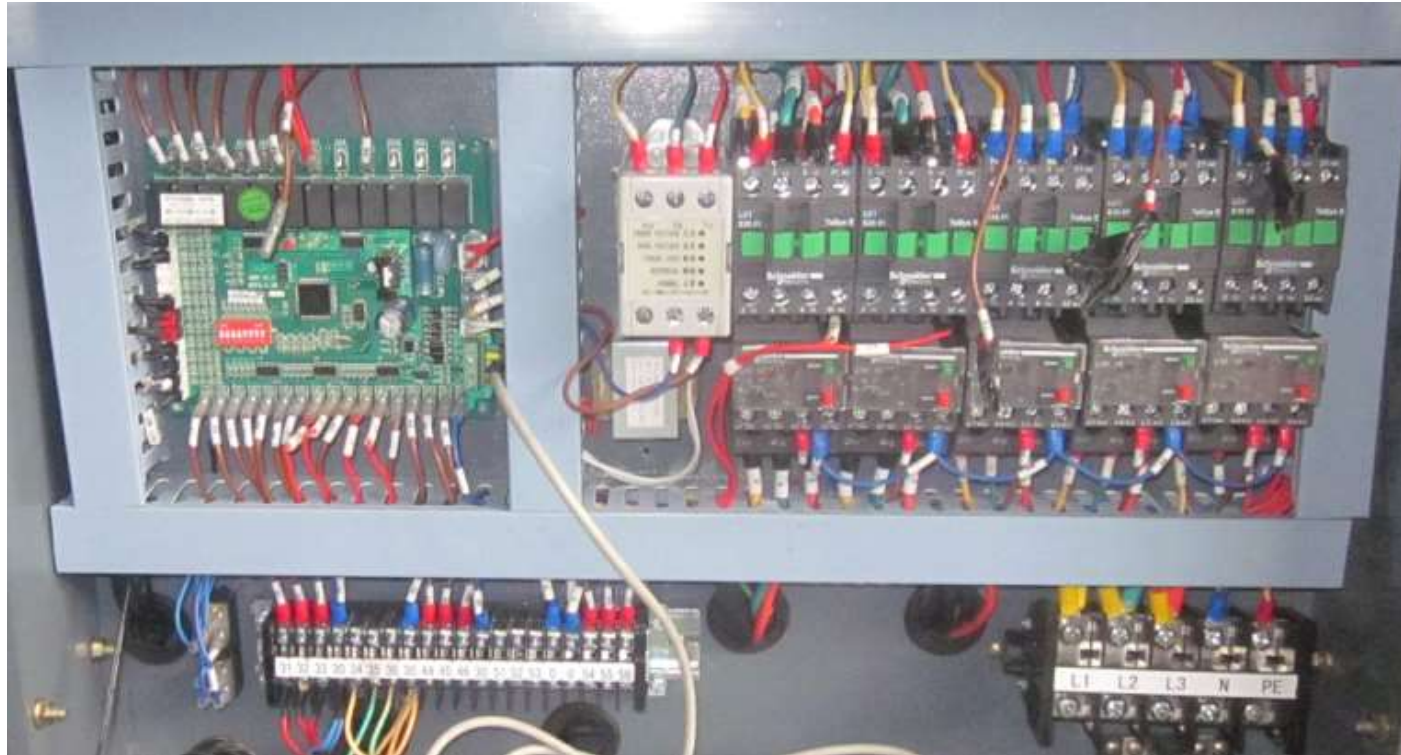

Units adopt microcomputer automatic control, LCD working platform, more convenient and reliable operation.

Electrical control system

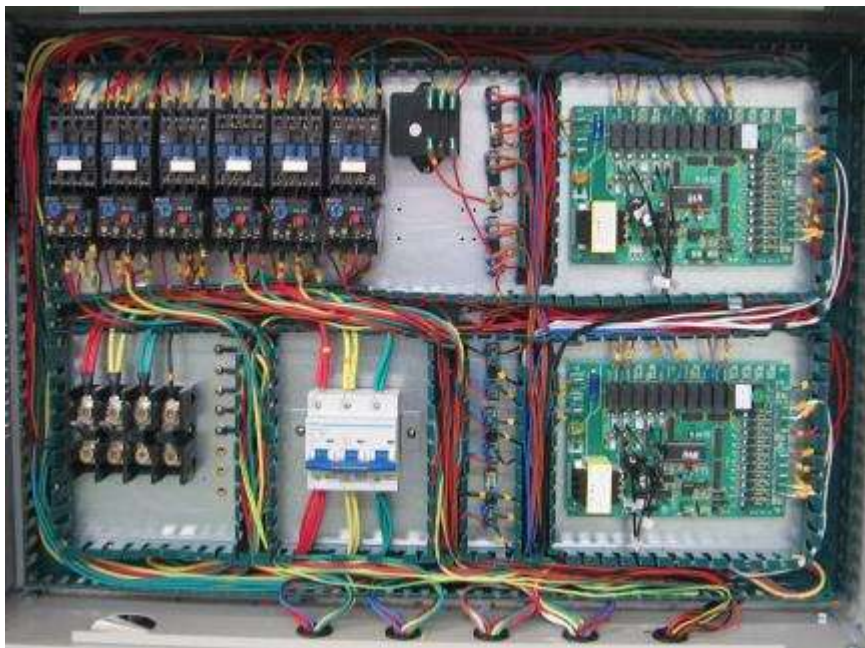

Units adopt microcomputer automatic control, LCD working platform, more convenient and reliable operation.

— LCD Controller Display —



— Remote Monitoring —

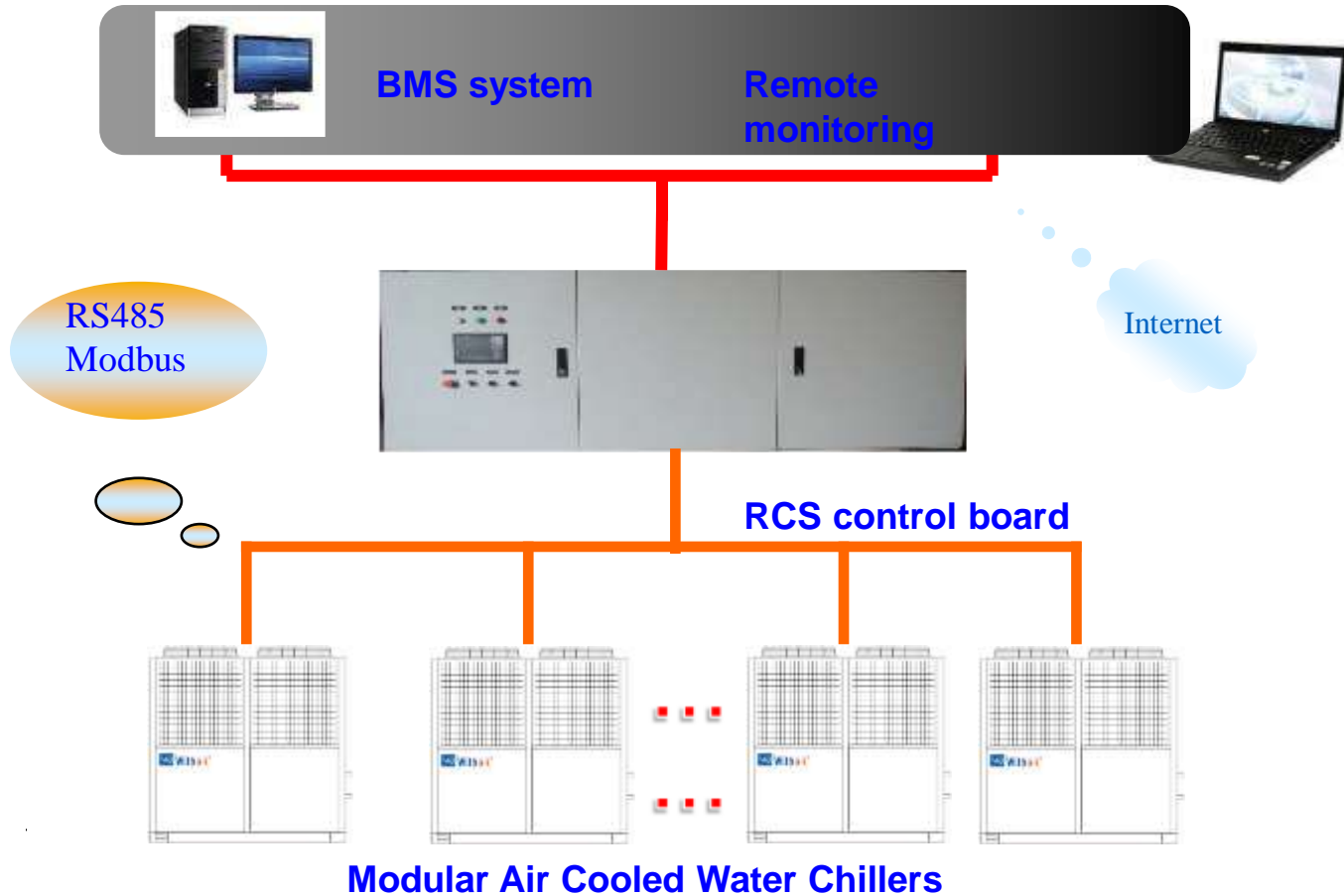

Modular Networking



Units adopt modular networking technology, modular units could be increased or decreased according to practical load, convenient and fast for combination.

— Independent Refrigerant System —



Each refrigeration system of the units is independent from each other, we could respectively test and repair one modular unit, or one system in it without impacting performance of the whole units, convenient to repair and maintain.

— Heat Recovery —



Units have heat recovery function, could freely supply hot water use.

Protection Items

<i>Water flow cutout</i>	<i>Power Fault protection</i>
<i>Anti-freeze protection</i>	<i>Contactors Fault protection</i>
<i>High-pressure alarm</i>	<i>Discharge temperature too high</i>
<i>Low-pressure alarm</i>	<i>Fin temperature too high</i>
<i>Compressor Inside Protection</i>	<i>Water Inlet/outlet temperature sensor</i>
<i>Oil level protection</i>	<i>Ambient temperature sensor open/short circuit</i>
<i>Oil pressure differential protection</i>	<i>Coil temperature sensor open/short circuit</i>
<i>Compressor overload protection</i>	<i>Discharge temperature sensor open/short circuit</i>
<i>Fan overload protection</i>	<i>- - -</i>

— Main Components —

The main components of Withair chiller are all selected famous brand products with excellent performance, so that the performance and reliability of the whole units are strongly guaranteed.

Some main components is as follows:

1. Compressors

Strong cooperation and creating high quality



2. Refrigerant accessories



3. Electric parts



— Specifications (ON/OFF Version , Standard Single Modular Unit) —

Model No.		W02C1-72	W02C1-105	W02C1-140	W02C1-175	W02C1-210	W02C1-280	W02C1-363	W02C1-565	
Nominal cooling capacity	kW	72	105	140	175	210	280	363	565	
	US.RT	20	30	40	50	60	80	100	160	
	EER	3.35	3.36	3.33	3.35	3.36	3.38	3.38	3.35	
Compressor	Type	Advanced fully hermetic scroll compressor								
	Brand name	Daikin, Copeland, Hitachi, Panasonic, Mitsubishi as option								
	Quantity	2	2	2	4	4	4	8	8	
	Input power	kW	19.2	27.0	36.0	46.7	56.1	74.5	96.9	150.6
Safe protection device		High/low pressure switch, overload protection, counter clock wise and short phase protection (power phases sequence protection),lack water(water-flow switch),anti-freezing protection, etc.								
Air side heat exchanger (Condenser)	Type	High efficiency exchanger copper tube and aluminum fin coil								
	Air flow volume	m³/h	24000	36000	45000	76000	112000	142000	168000	284000
	Fan motor type	Low noise, high efficiency, waterproof and weatherproof axial flow type								
	Fan motor power	kW	1.4	2.0	2.8	4.5	6.0	9.2	11.7	17.1
Water side heat exchanger (Evaporator)	Type	High efficiency shell-and-tube heat exchanger								
	Water flow rate	m³/h	11.7	16.5	21.4	29.3	35.6	44.8	58.5	90.2
	Water pressure drop	kPa	40 ~ 80							
	Max. working pressure	MPa	1							
Dimension	Length*width*height	mm	2065*1030*1974	2316*1306*2360		4360*2290*2020		4710*2290*2020	5650*2260*2590	9420*2290*2590
Noise level		dB(A)	65	68	71	73	74	76	78	83
Water proof level			IPX4							
Electric shock protection			I							
Refrigerant	Type	HFC- R410A								
	Charging rate	kg	16	25	30	43	55	62	84	128
Net weight		kg	840	1350	1880	2720	3150	3860	4290	7850
Entering/leaving water pipe		Inch	2-1/2"	2-1/2"	2-1/2"	3"	3"	3"	3"	3"
Power supply		kW	380V/3P/50Hz (400V/415V/3P/50Hz, 230V/380V/460V/3P/60Hz as option)							
Control type			Wired control, manual or automatic start up, the running status display and malfunction alarm, etc.							

Various Models Combines Capacity Parameter Table



Model & modular quantity	W02C1-72	1	2	3	4	5	6	7	8	9	10	11	12	13	14	15	16
Cooling capacity	kW	72	144	216	288	360	432	504	576	648	720	792	864	936	1008	1080	1152
Water flow rate	m³/h	11.7	23.4	35.1	46.8	58.5	70.2	81.9	93.6	105.3	117	128.7	140.4	152.1	163.8	175.5	187.2
Model & modular quantity	W02C1-105	1	2	3	4	5	6	7	8	9	10	11	12	13	14	15	16
Cooling capacity	kW	105	210	315	420	525	630	735	840	945	1050	1155	1260	1365	1470	1575	1680
Water flow rate	m³/h	16.5	33	49.5	66	82.5	99	115.5	132	148.5	165	181.5	198	214.5	231	247.5	264
Model & modular quantity	W02C1-140	1	2	3	4	5	6	7	8	9	10	11	12	13	14	15	16
Cooling capacity	kW	140	280	420	560	700	840	980	1120	1260	1400	1540	1680	1820	1960	2100	2240
Water flow rate	m³/h	21.4	42.8	64.2	85.6	107	128.4	149.8	171.2	192.6	214	235.4	256.8	278.2	299.6	321	342.4
Model & modular quantity	W02C1-175	1	2	3	4	5	6	7	8	9	10	11	12	13	14	15	16
Cooling capacity	kW	175	350	525	700	875	1050	1225	1400	1575	1750	1925	2100	2275	2450	2625	2800
Water flow rate	m³/h	29.3	58.6	87.9	117.2	146.5	175.8	205.1	234.4	263.7	293	322.3	351.6	380.9	410.2	439.5	468.8
Model & modular quantity	W02C1-210	1	2	3	4	5	6	7	8	9	10	11	12	13	14	15	16
Cooling capacity	Kw	210	420	630	840	1050	1260	1470	1680	1890	2100	2310	2520	2730	2940	3150	3360
Water flow rate	m³/h	35.6	71.2	106.8	142.4	178	213.6	249.2	284.8	320.4	356	391.6	427.2	462.8	498.4	534	569.6
Model & modular quantity	W02C1-280	1	2	3	4	5	6	7	8	9	10	11	12	13	14	15	16
Cooling capacity	kW	280	560	840	1120	1400	1680	1960	2240	2520	2800	3080	3360	3640	3920	4200	4480
Water flow rate	m³/h	44.8	89.6	134.4	179.2	224	268.8	313.6	358.4	403.2	448	492.8	537.6	582.4	627.2	672	716.8
Model & modular quantity	W02C1-363	1	2	3	4	5	6	7	8	9	10	11	12	13	14	15	16
Cooling capacity	kW	363	726	1089	1452	1815	2178	2541	2904	3267	3630	3993	4356	4719	5082	5445	5808
Water flow rate	m³/h	58.5	117	175.5	234	292.5	351	409.5	468	526.5	585	643.5	702	760.5	819	877.5	936
Model & modular quantity	W02C1-565	1	2	3	4	5	6	7	8	9	10	11	12	13	14	15	16
Cooling capacity	kW	565	1130	1695	2260	2825	3390	3955	4520	5085	5650	6215	6780	7345	7910	8475	9040
Water flow rate	m³/h	90.2	180.4	270.6	360.8	451	541.2	631.4	721.6	811.8	902	992.2	1082.4	1172.6	1262.8	1353	1443.2

— Performance Parameter Correction Factor Table —

Cooling capacity

LWT (°C)	Ambient temperature (°C)											
	20		25		30		35		40		45	
	Cooling capacity	Input power	Cooling capacity	Input power	Cooling capacity	Input power	Cooling capacity	Input power	Cooling capacity	Input power	Cooling capacity	Input power
5	1.07	0.74	1.02	0.81	0.98	0.89	0.94	0.99	0.90	1.06	0.85	1.19
7	1.14	0.76	1.08	0.82	1.04	0.90	1.00	1.00	0.96	1.09	0.92	1.20
9	1.20	0.78	1.15	0.84	1.11	0.92	1.07	1.02	1.03	1.10	0.98	1.23
12	1.29	0.80	1.26	0.86	1.21	0.94	1.16	1.03	1.12	1.12	1.08	1.25
15	1.39	0.82	1.35	0.88	1.30	0.95	1.26	1.05	1.22	1.16	1.18	1.27
Note: LWT - leaving water temperature, EWT - entering water temperature												

Note: Above correction factors adapt to W02C1-72, W02C1-105, W02C1-140, W02C1-175, W02C1-210, W02C1-280, W02C1-363, W02C1-565

— Specifications (Cooling Only With 40% Partial Heat Recovery) —

Model No.		W02C1-72PH	W02C1-105PH	W02C1-140PH	W02C1-175PH	W02C1-210PH	W02C1-280PH	W02C1-363PH	W02C1-565PH	
Nominal cooling capacity	kW	72	105	140	175	210	280	363	565	
	US.RT	20	30	40	50	60	80	100	160	
	EER	3.35	3.36	3.33	3.35	3.36	3.38	3.38	3.35	
Control type		Wired control, manual or automatic start up, the running status display and malfunction alarm, etc.								
Partial Heat Recovery (40%) DHW (domestic hot water)	kW	28.8	42.0	56.0	70.4	84.0	112.0	145.2	226	
	EWT	Entering water temperature: 15°C								
	LWT	Leaving water temperature: 55°C								
Power supply		380V/3P/50Hz (400V/415V/3P/50Hz, 230V/380V/460V/3P/60Hz as option)								
Compressor	Type	Advanced fully hermetic scroll compressor								
	Brand name	Daikin, Copeland, Hitachi, Panasonic, Mitsubishi as option								
	Quantity	2	2	2	4	4	4	8	8	
	Input power	kW	19.2	27.0	36.0	46.7	56.1	74.5	96.9	150.6
Safe protection device		High/low pressure switch, overload protection, counter clock wise and short phase protection (power phases sequence protection),lack water(water-flow switch),anti-freezing protection, etc.								
Air side heat exchanger (Condenser)	Type	High efficiency exchanger copper tube and aluminum fin coil								
	Air flow volume	m³/h	24000	36000	45000	76000	112000	142000	168000	284000
	Fan motor type	Low noise, high efficiency, waterproof and weatherproof axial flow type								
	Fan motor power	kW	1.4	2	2.8	4.5	6	9.2	11.7	17.1
Water side heat exchanger (Evaporator)	Type	High efficiency shell-and-tube heat exchanger								
	Water flow rate	m³/h	11.7	16.5	21.4	29.3	35.6	44.8	58.5	90.2
	Water pressure drop	kPa	40~80							
	Max. working pressure	MPa	1							
Dimension	Length*width*height	mm	2065*1030*1974	2316*1306*2360		4360*2290*2020		4710*2290*2020	5650*2260*2590	9420*2290*2590
Noise level		dB(A)	65	68	71	73	74	76	78	83
Water proof level		IPX4								
Electric shock protection		I								
Refrigerant	Type	HFC- R410A								
	Charging rate	kg	16	25	30	43	55	62	84	128
Net weight		kg	840	1350	1880	2720	3150	3860	4290	7850
Entering/leaving water pipe		Inch	2-1/2"	2-1/2"	2-1/2"	3"	3"	3"	3"	3"

Performance Parameter Correction Factor Table



Cooling capacity

LWT (°C)	Ambient temperature (°C)											
	20		25		30		35		40		45	
	Cooling capacity	Input power	Cooling capacity	Input power	Cooling capacity	Input power	Cooling capacity	Input power	Cooling capacity	Input power	Cooling capacity	Input power
5	1.07	0.74	1.02	0.81	0.98	0.89	0.94	0.99	0.90	1.06	0.85	1.19
7	1.14	0.76	1.08	0.82	1.04	0.90	1.00	1.00	0.96	1.09	0.92	1.20
9	1.20	0.78	1.15	0.84	1.11	0.92	1.07	1.02	1.03	1.10	0.98	1.23
12	1.29	0.80	1.26	0.86	1.21	0.94	1.16	1.03	1.12	1.12	1.08	1.25
15	1.39	0.82	1.35	0.88	1.30	0.95	1.26	1.05	1.22	1.16	1.18	1.27
Note: LWT - leaving water temperature, EWT - entering water temperature												

Heat recovery capacity

Ambient temperature (°C)	LWT (°C)										
	30		40		45		50		55		
	Cooling capacity	Input power	Cooling capacity	Input power	Cooling capacity	Input power	Cooling capacity	Input power	Cooling capacity	Input power	
30	1.25	0.82	1.22	0.88	1.19	0.94	1.15	0.99	1.12	1.03	
25	1.18	0.81	1.15	0.87	1.12	0.93	1.09	0.97	1.06	1.01	
20	1.11	0.80	1.09	0.86	1.06	0.92	1.03	0.96	1.00	1.00	
15	1.05	0.79	1.02	0.84	1.00	0.91	0.97	0.95	0.94	0.99	
10	0.99	0.78	0.97	0.83	0.94	0.90	0.91	0.93	0.89	0.97	
5	0.80	0.75	0.83	0.81	0.79	0.87	0.76	0.91	0.74	0.94	
0	0.78	0.74	0.72	0.79	0.68	0.85	0.65	0.88	0.63	0.91	
-5	0.73	0.71	0.59	0.74	0.54	0.81	-	-	-	-	
-10	0.52	0.68	0.47	0.69	-	-	-	-	-	-	
Note: LWT - leaving water temperature, EWT - entering water temperature											

Technical Data (Year-round Cooling Modular Unit, Standard Single Unit)

Model No.		W01R1-72YRC	W01R1-105YRC	W01R1-140YRC	
Nominal cooling capacity	kW	72	105	140	
	US.RT	20	30	40	
	EER	3.35	3.36	3.33	
Control type	Wired control, manual or automatic start up, the running status display and malfunction alarm, etc.				
Power supply	380V/3P/50Hz (400V/415V/3P/50Hz, 230V/380V/460V/3P/60Hz as option)				
Compressor	Type	Advanced fully hermetic scroll compressor			
	Brand name	Daikin, Copeland, Hitachi, Panasonic, Mitsubishi as option			
	Quantity	2	2	2	
	Input power	kW	19.2	27.0	36.0
Safe protection device	High/low pressure switch, overload protection, counter clock wise and short phase protection (power phases sequence protection),lack water(water-flow switch),anti-freezing protection, etc.				
Air side heat exchanger (Condenser)	Type	High efficiency exchanger copper tube and aluminum fin coil			
	Air flow volume	m ³ /h	24000	36000	45000
	Fan motor type	Low noise, high efficiency, waterproof and weatherproof axial flow type			
	Fan motor power	kW	1.4	2.0	2.8
Water side heat exchanger (Evaporator)	Type	High efficiency shell-and-tube heat exchanger			
	Water flow rate	m ³ /h	11.7	16.5	21.4
	Water pressure drop	kPa	40 ~ 80		
	Max. working pressure	MPa	1		
Dimension	Length*width*height	mm	2221*1004*2263	2221*1004*2263	2221*1004*2263
Noise level		dB(A)	65	68	71
Water proof level	IPX4				
Electric shock protection	I				
Refrigerant	Type	HFC- R410A			
	Charging rate	kg	16	25	30
Net weight		kg	840	1350	1880
Entering/leaving water pipe		Inch	2-1/2"	2-1/2"	2-1/2"
Working range(cooling in year round)		°C	- 10 ~ 48		
Control type	Wired control, manual or automatic start up, the running status display and malfunction alarm, etc.				

—— Year-round Cooling Capacity Correction Factor Table ——

LWT (°C)	Ambient temperature (°C)															
	-10		-5		0		7		15		25		35		48	
	Cooling capacity	Input power	Cooling capacity	Input power	Cooling capacity	Input power	Cooling capacity	Input power	Cooling capacity	Input power	Cooling capacity	Input power	Cooling capacity	Input power	Cooling capacity	Input power
0	1.01	0.65	0.99	0.73	0.97	0.69	0.96	0.69	0.98	0.72	0.92	0.82	0.84	0.94	0.68	1.12
5	1.11	0.68	1.09	0.76	1.07	0.72	1.06	0.72	1.08	0.75	1.02	0.85	0.94	0.97	0.78	1.15
7	1.17	0.71	1.15	0.79	1.13	0.75	1.12	0.75	1.14	0.78	1.08	0.88	1.00	1.00	0.84	1.18
10	1.25	0.75	1.23	0.83	1.21	0.79	1.20	0.79	1.22	0.82	1.16	0.92	1.08	1.04	0.92	1.22
15	1.35	0.80	1.33	0.88	1.31	0.84	1.30	0.84	1.32	0.87	1.26	0.97	1.18	1.09	1.02	1.27
20	1.43	0.84	1.41	0.92	1.39	0.88	1.38	0.88	1.40	0.91	1.34	1.01	1.26	1.13	1.10	1.31

Note: LWT - leaving water temperature, EWT - entering water temperature

Note: Above correction factors adapt to W01R1-72YRC, W01R1-105YRC, W01R1-140YRC

— Operating Conditions —

Notes:

1. Nominal cooling operating conditions: entering chilled water temperature 12°C, leaving temperature 7°C; outdoor dry bulb temperature 35°C, wet bulb temperature 24°C.
2. The controllers need to be ordered separately, including wire controller, communication line, IOM, temperature sensor and water flow switch.
3. These parameters were tested according to pure water, not including anti-freezing liquid and water pump power.
4. In actual use, the cooling loss should be considered after the installation of the system piping, pumps, valves, dirt, etc. about 6%.
5. For other working conditions or capacity parameters, please contact Withair for cooling ambient conditions under 5°C.
6. There will be no further notice if the parameters change due to product optimization.
7. The units of the same model or different models can be combined freely. Each system can combine up to 16 modules.
8. Manufacturer reserves the right to make changes to the above specifications without prior notice, please refer to the factory configuration when purchasing.

Conditions	Water side				Air side	
	Nominal working condition		Working range		Nominal working condition	Working range
	EWT (°C)	LWT (°C)	EWT (°C)	LWT (°C)	Dry bulb temperature (°C)	Dry bulb temperature of outdoor (°C)
Cooling	12	7	5 ~ 15	2.5 ~ 8	35	12 ~ 50
Note: LWT - leaving water temperature, EWT - entering water temperature						

Electric Diagram

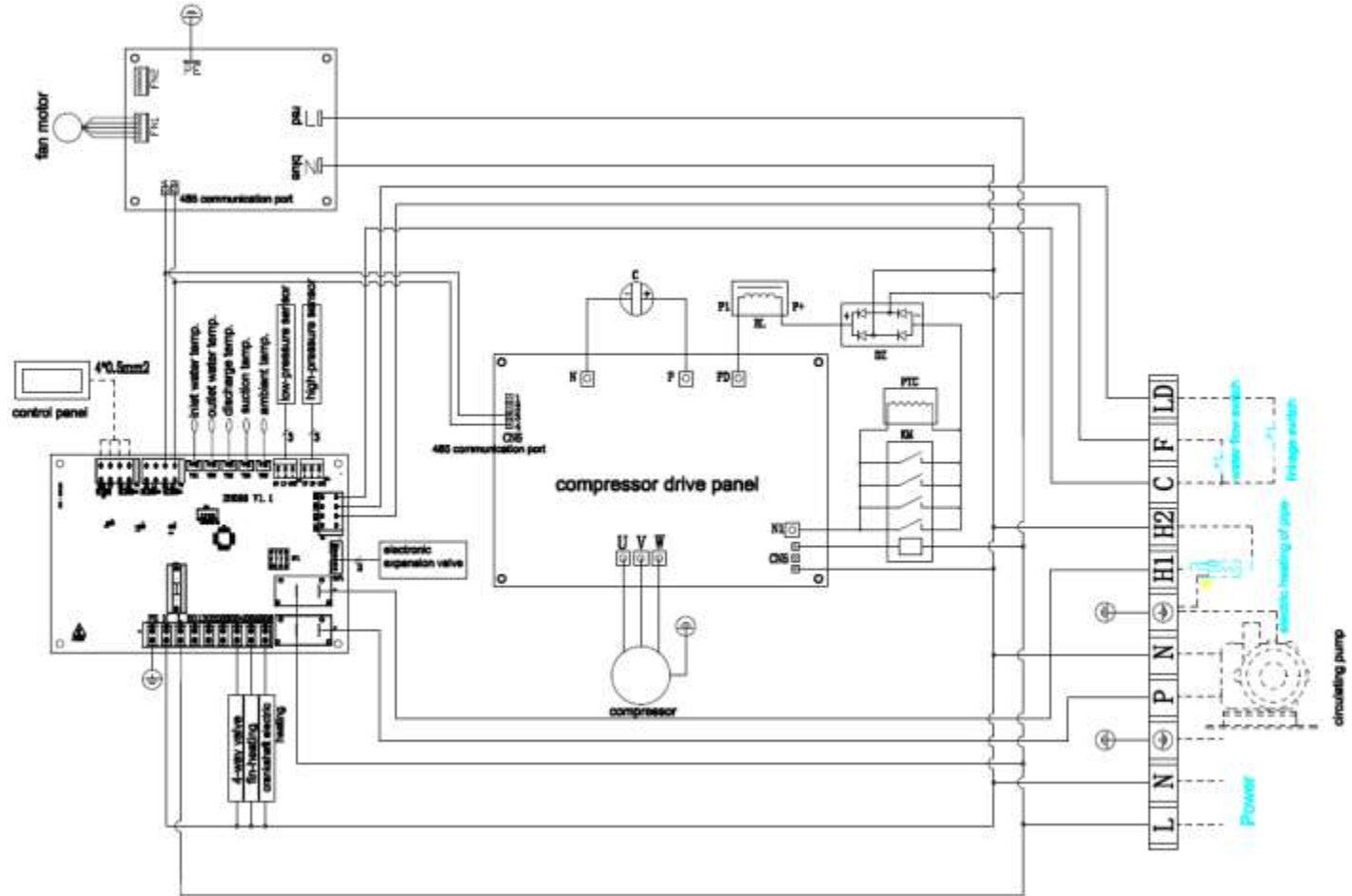

Electric Diagram

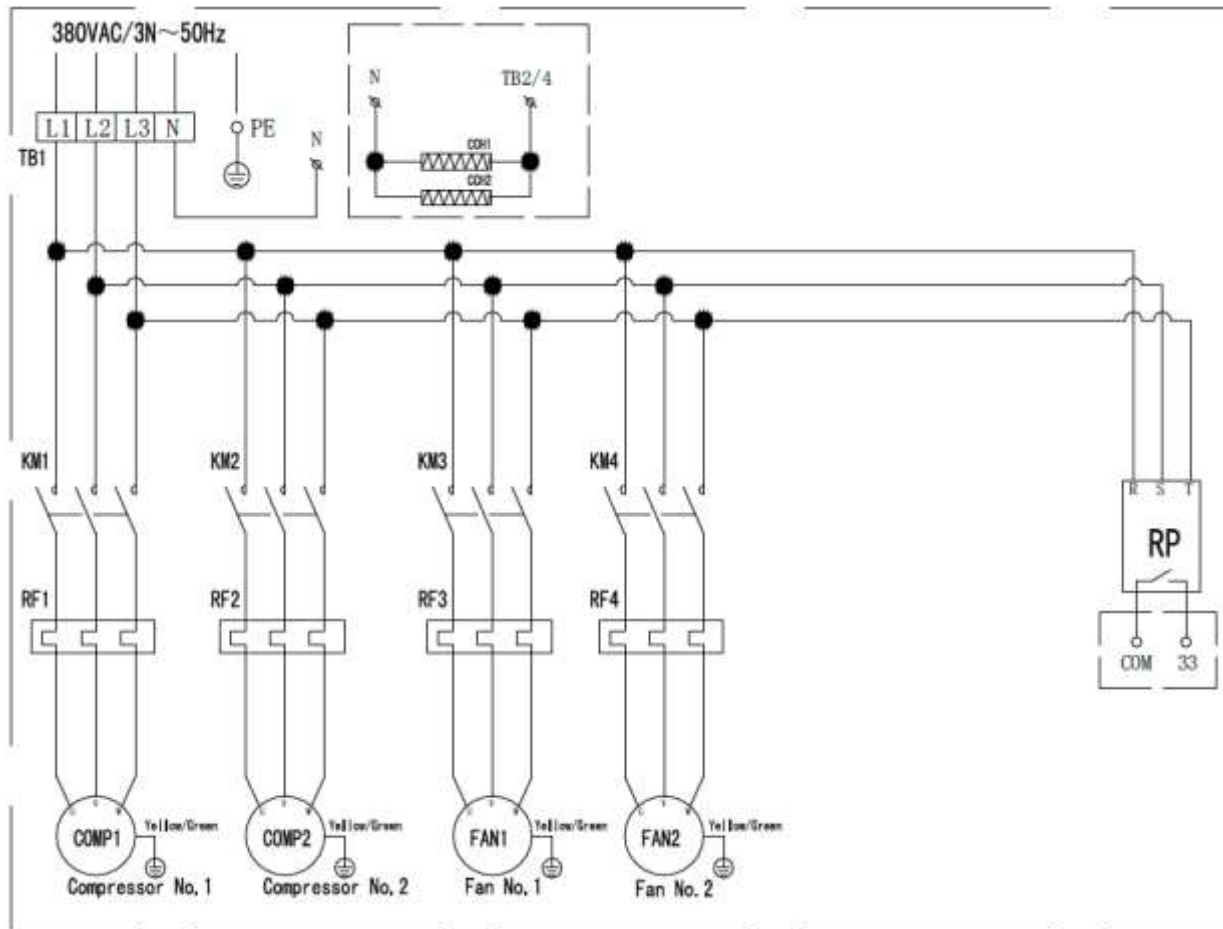

Electric Diagram

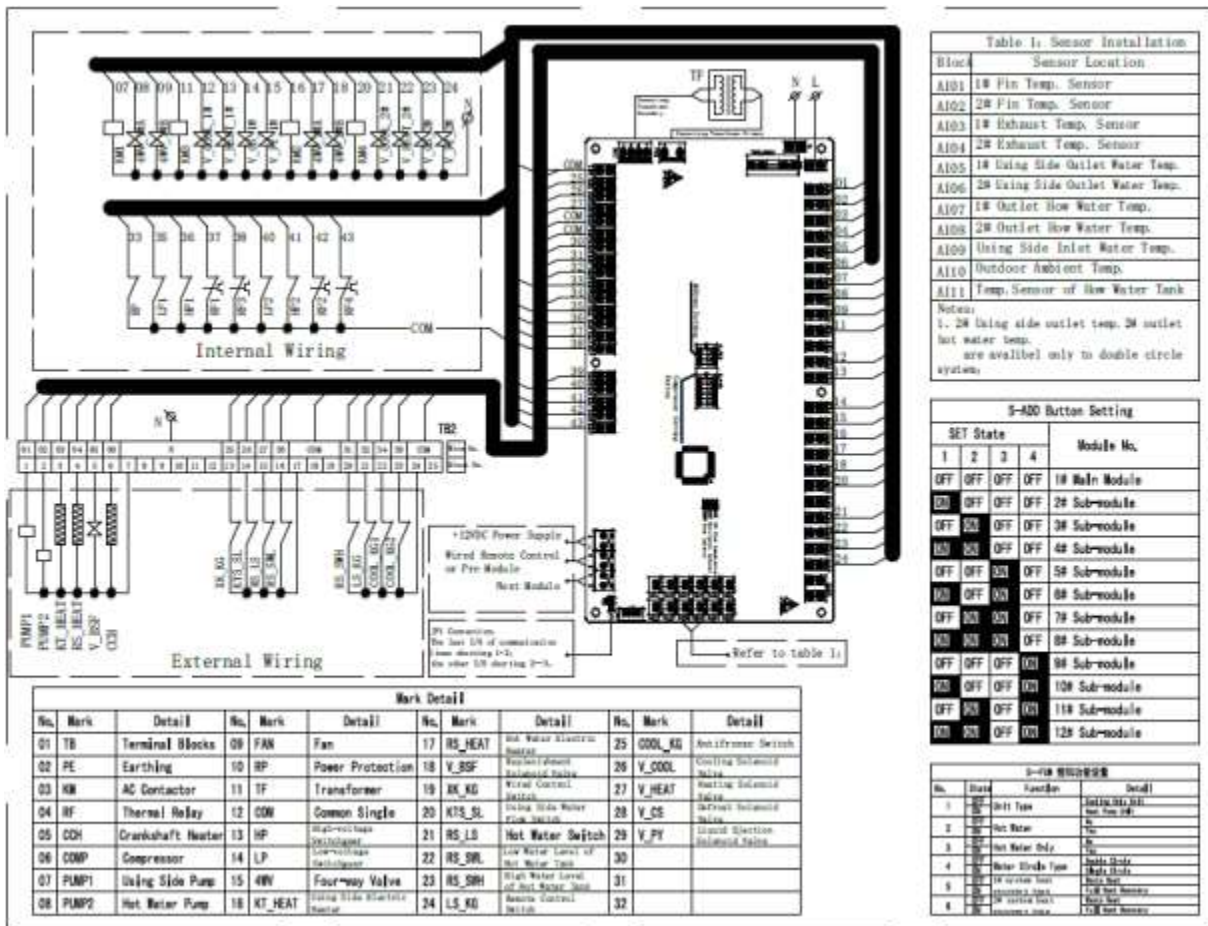

Electric Diagram

Character Note			
No. Character	Note	No. Character	Note
B1 TB	Terminal block	B7 PMP2	Hot water side water pump
B2 PE	Ground	B8 PF	Fuse protection
B3 B1	A.C. condenser	B9 TF	Transformer
B4 BF	Thermal relay	B10 SW	Public communication
B5 BDI	Crack heater lead	B11 HP	High pressure switch
B6 COMP	Compressor	B12 LP	Low pressure switch
B7 PMP1	Cooling side water pump	B13 BV	Four valves
B8 PMP2	Hot water side water pump		

Dial function setting			
Dial	Setting	Function	Note
5	0F	Unit type	Only cooling type
	0H	Unit type	Cooling and heating type
6	0F	Water system option	Double water system
	0H	Water system option	Single water system
7	0F	Hot water option	No
	0H	Hot water option	Yes
8	0F	16.26 compressor option	No
	0H	16.26 compressor option	Yes

Note: Unit function set dial 5 & dial 7. only main module (#1) available, submodule is not available.

Module dial switch set				Module dial switch set					
SET Dial 4 dial status				Module No.	SET Dial 4 dial status				Module No.
1	2	3	4		1	2	3	4	
0F	0F	0F	0F	16 module	0F	0H	0F	0F	26 module
0F	0F	0F	0H	26 module	0F	0H	0H	0F	36 module
0F	0F	0H	0F	36 module	0F	0H	0H	0H	46 module
0F	0H	0F	0F	46 module	0F	0H	0H	0H	56 module
0F	0H	0H	0F	56 module	0H	0F	0F	0F	66 module
0H	0F	0F	0F	66 module	0H	0F	0H	0F	76 module

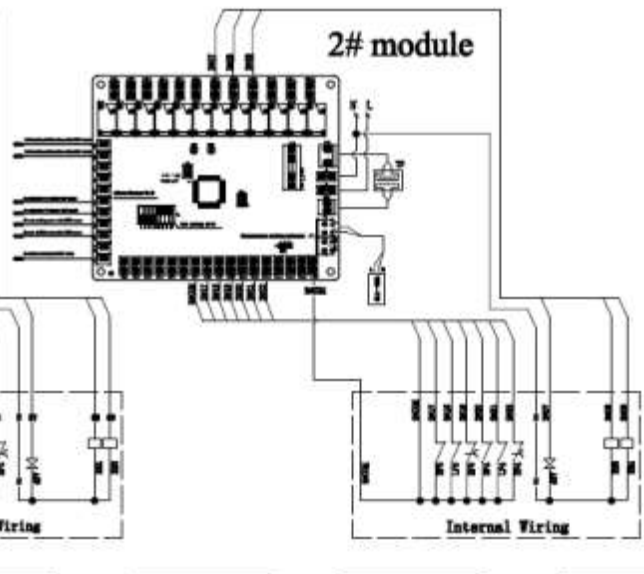
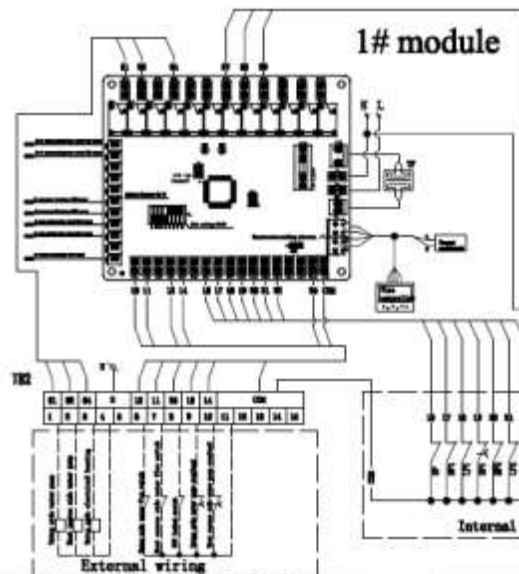
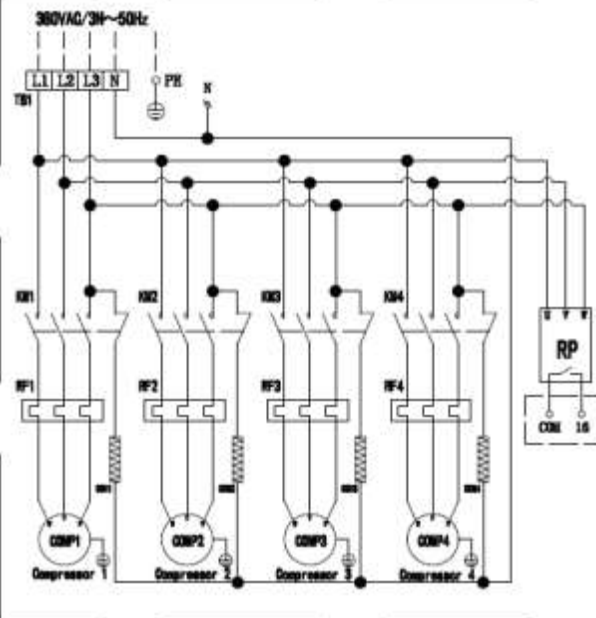

System Schematic Diagram

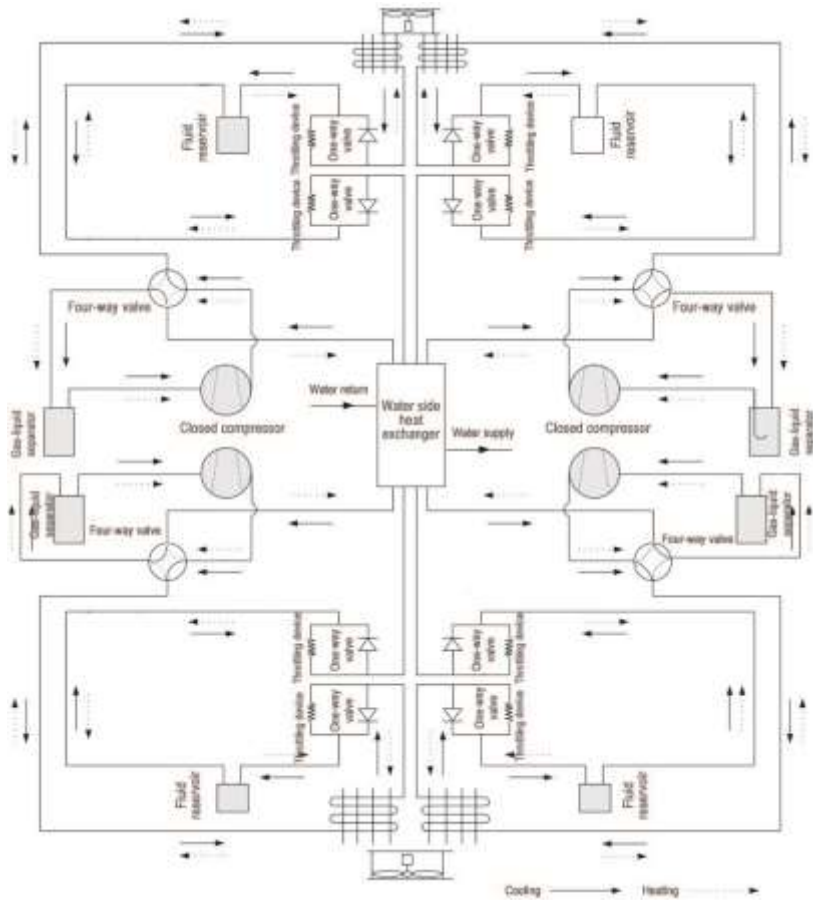

Four Compressors System

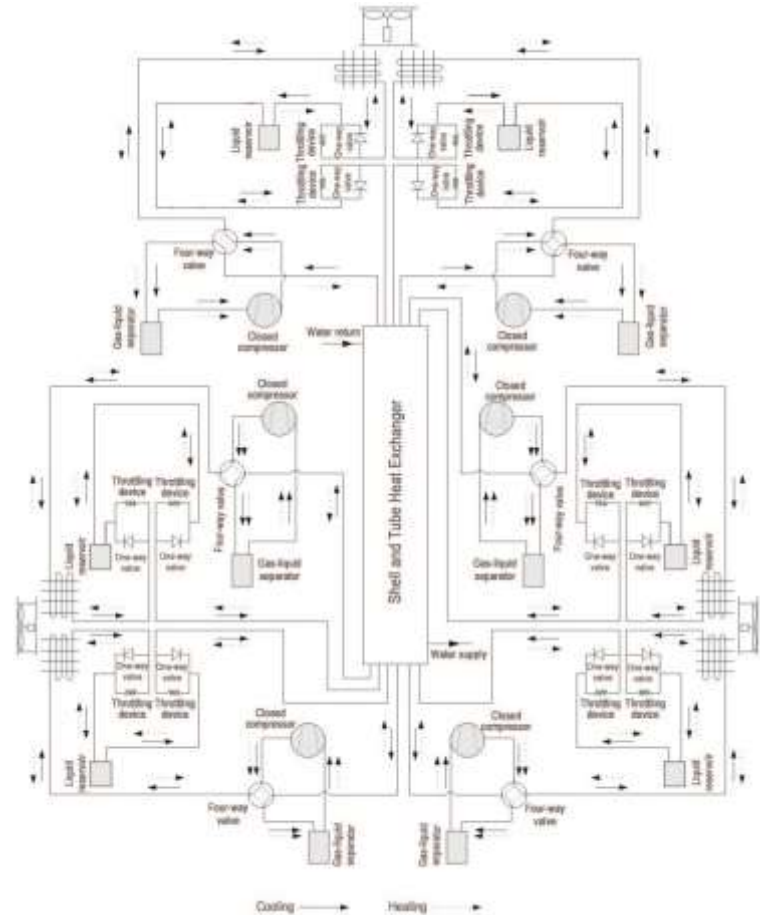

Six Compressors System

Power Connection

- 1) Wire selection and connection should be carried out strictly according to requirement.
- 2) Should have earthing well done, no earthing to gas pipe, water pipe, telephone line, to avoid electric shock caused by improper earthing.
- 3) Ensure the phase sequence is correct, to avoid not running.

Maintenance

- 1) The qualified technician is required for the maintenance; all the protection devices and controller must be checked before restart.
- 2) Regular and correct maintenance is required for stability and good performance. Chilled and cooling water must be complete drained when long time no use to avoid possible freezing.

7. Notice

- 1) Antifreeze should be added in chilled water if water temperature set below zero or near zero.
- 2) Clean water system regularly.
- 3) Pay attention to antifreeze when ambient temp. is around 0°C in winter.
- 4) Antifreeze or other antifreeze measure must be used in bad ambient(under 0°C outdoor).

Installation Spaces

☆ Installation location

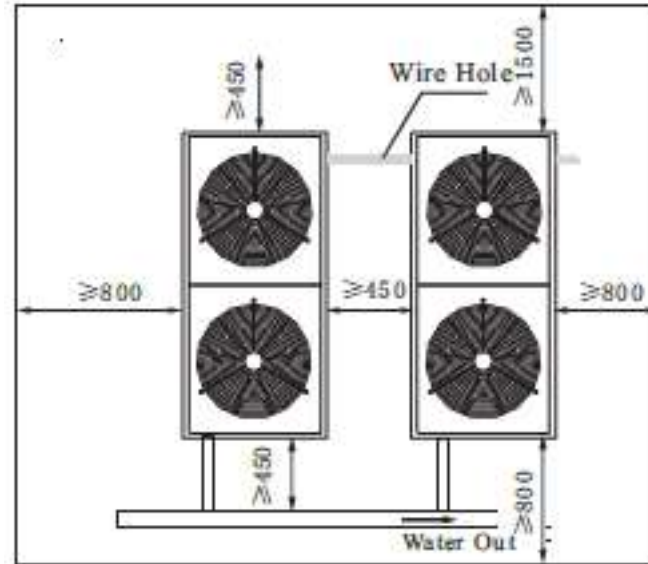
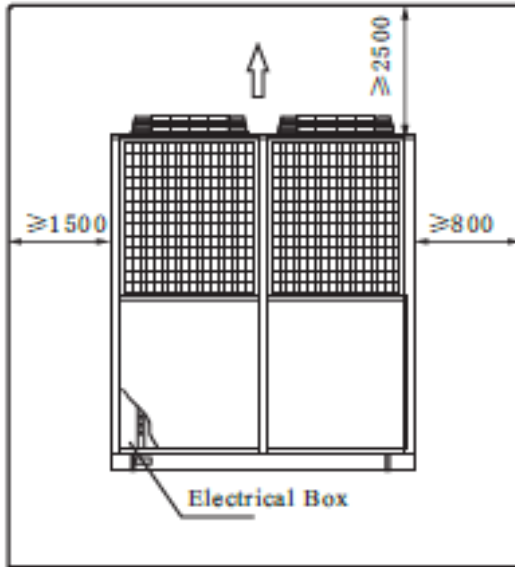

- A). Near to in the indoor terminal, reducing water system resistance losses.
- B). Near to the power and convenient for wiring connection.
- C). Near to the water source and convenient for installation.
- D). Strong enough to support unit weight and running vibration.
- E). Enough space in order to install, repair, maintenance.
- F). Water source not near to the dirty and corrosive fluid, keep pure water, water chlorinity does not exceed 25ppm

Water System Installation I

☆ Water system illustration for user side

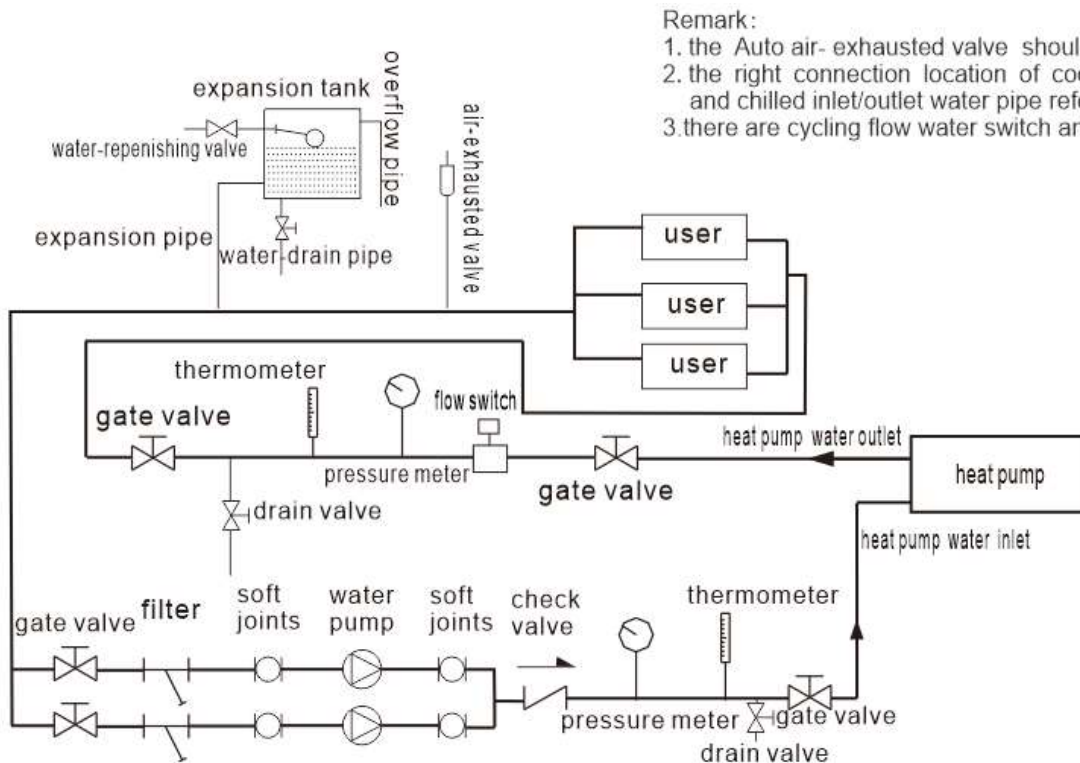

Remark:

1. the Auto air- exhausted valve should install at the top of pipe system.
2. the right connection location of cooling inlet/out water pipe and chilled inlet/outlet water pipe refer to the label of heat pump.
3. there are cycling flow water switch and cooling water flow switch each.

Water System Installation II

Note: Automatic exhaust valve should be installed at top of the whole water circulation system.

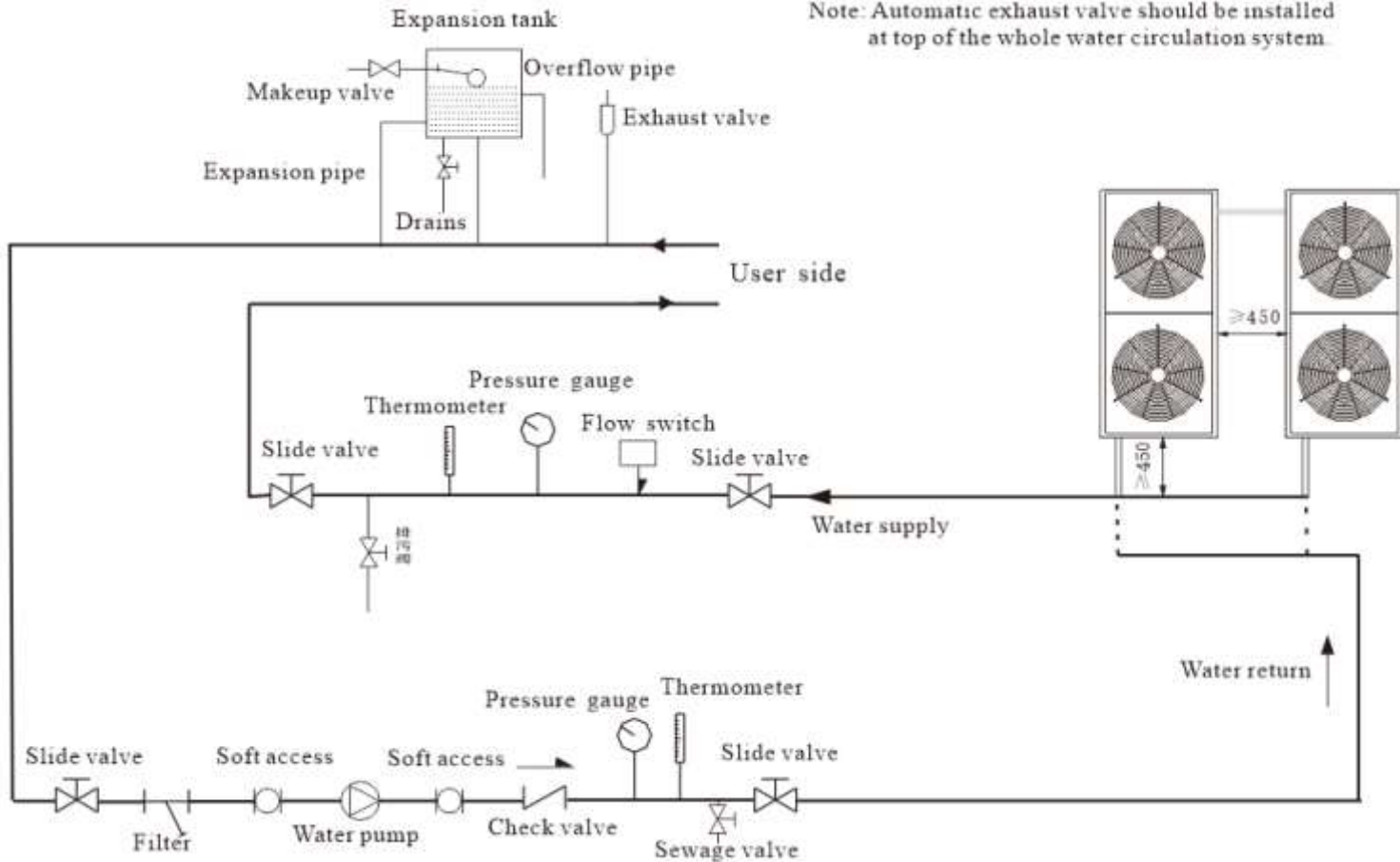

Engineering Guide

Assembly and Test

The unit shall be completely factory assembled, pre-charged and wired. Complete unit must be test operated at factory prior to shipment.

Refrigerant System

Each refrigerant circuit shall include a high-efficiency scroll compressor, high pressure control, low pressure control, TXV, and refrigerant pressure gauge connections.

Electrical

The unit shall have 24-volt electromechanical controls and include compressor contactors, 24-volt transformer, terminal strip, compressor staggered start, fault lockout circuit, compressor anti-short cycle, low pressure switch by-pass timer, LED for compressor ON/OFF and fault status, and the necessary relays for compressor and reversing valve operation.

The reversing valve is energized in the cooling mode.

Installation and Maintenance

1. The preparation

- 1) After arriving the installation site, check all the items of the unit carefully according to the packing list if there are damage, lack of parts or damage during transport, notify the sales department.
- 2) The user must provide a rigid nondeforming foundation or concrete footings, based on the size of the unit four positioning hole; the foundation of the unit can also be framework structure, framework should be placed on main beam or column, and be capable of bearing the weight 150% heavier than the unit. The horizontal level should have no slope.
- 3) For easy handling, users should use the crane, the machine should properly protected by soft material on the point of force applied, and also be in balanced status during handling to avoid possible damage.
- 4) Choose the Installation Place
Units can be installed indoor or outdoor, should consider the following factors:
 - a) Installation place should be capable of bearing the weight 150% heavier than the unit. The horizontal level should have no slope.
 - b) Should keep enough space surrounding and on the top of the machine for access of maintenance.
 - c) Should have drain in the surrounding of the machine for release the water for seasonal stop of machine.
- 5) Foundation reference
Note:
 - a) The foundation should be concreted structure or frame of steel, with a plane surface
 - b) 10-20mm isolator for shock absorption should be placed between the unit and foundation.
 - c) Foundation design can based on the machine net weight.
 - d) Fix the unit with $\phi 16$ foundation bolt
 - e) foundation diagram

Installation Requirements

- (1) Be sure to take the base preparation and structure into consideration seriously during installation, particularly on rooftop installations in order to avoid noise and vibration. Consulting the building designer before conducting installation is recommended.
- (2) A drainage ditch should surround the base to ensure dewatering occurs
- (3) Anti-vibration pad is to be placed between the base frame and foundation in order to avoid vibrations and unnecessary noise, and make sure the unit is horizontal during installation.
- (4) The maximum altitude difference (levelness) should be within 3mm for the chiller base.
- (5) The base should be raised by 100mm.
- (6) The installation base of the unit must be concrete or steel structure, which can bear the running weight of the machine. The top should be horizontal. It is ideal to prepare a drainage ditch around installation base.
- (7) Put the steel plate and anti-vibration pad in the correct position. Finish the installation of the unit and the foundation bolt before secondary concreting. The foundation bolt should protrude 100mm.
- (8) Spring isolators are specified on the sales order as an option.

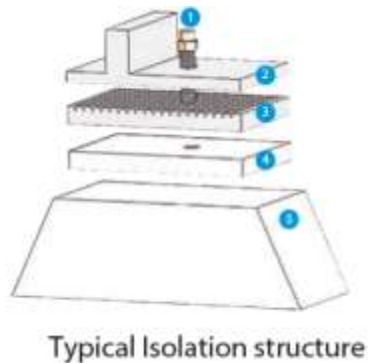

- 1 Anchor Bolt
- 2 Chiller Frame Base
- 3 Rubber Pad
- 4 Steel Base Plate
- 5 Concrete Base

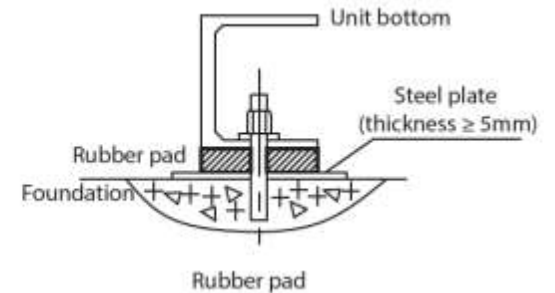
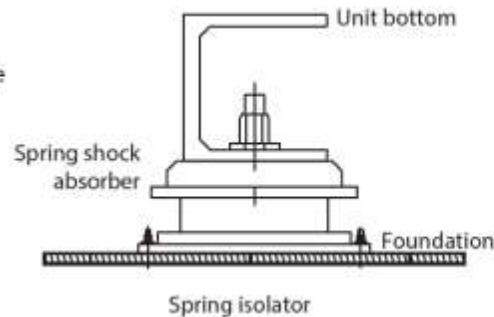

Unit Hoisting

- * Keep the package well from the factory to the job site;
- * Be careful when carrying the units to ensure the body vertical;
- * When lifting the unit, avoid it from hitting other objects to avoid sliding. At the same time the staff should avoid standing below or near the bottom of the unit to ensure safety;
- * In order to prevent scratches or deformation of appearance, cable section shall be placed in contact with the unit's protective pads, while support should be added between the ropes prevent damage machinery by ropes.
- * See the parameter table for the reference weight of the hoisting steel pipe, steel rope and lifting locomotive.
- * The hoisting steel pipe, steel rope and lifting locomotive reference weight see unit parameter table. Protect the inlet and outlet water pipe of the unit to avoid collision during the hoisting process.

Example lifting schematic

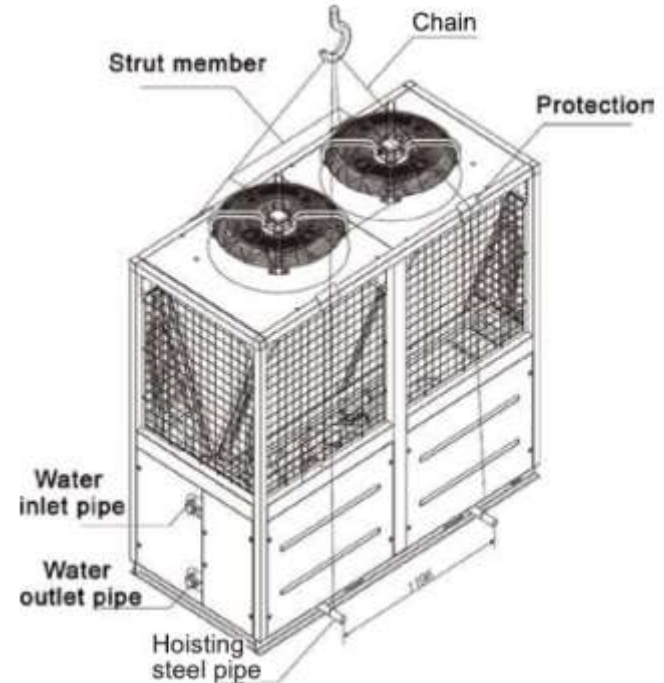

Projects Solutions

- Solution for Hotel : Heat Recovery Air-cooled Chiller + FCU + Floor Heating + Fresh Air Unit + Heat Pump Water Heater

System Introduction:

In addition to reliably guaranteeing the use of air conditioners, this system can also guarantee 24/7 hot water supply; in the cooling season, users can get free hot water while using air conditioners for cooling; the cooling water system is omitted, and low the initial investment. ; Dual-purpose cooling and heating, no additional heating system is required; different air handling equipment can be configured according to the needs of different functions, such as fan coil units, variable air volume units, fresh air units, air handling units, etc.; modular configuration of the unit, it can realize non-stop maintenance; intelligent control, realizing quasi-linear energy adjustment with load changes, the system does not need a dedicated machine room, so it can release the effective space of the building and realize its economic value.



Projects Solutions

● Solution for Office Building: Air-cooled Water Chiller + Fan Coil Unit + Fresh Air Unit

System Introduction:

In addition to the reliable protection of the air conditioner, the system eliminates the need for a cooling water system and has a small initial investment; it is dual-purpose for cooling and heating, without the need for additional heating systems; it can be equipped with different air handling equipment, such as fan disks, according to the needs of different functions Tubes, variable air volume units, fresh air units, combined air handlers; the modular configuration of the main engine can realize non-stop maintenance; intelligent control realizes quasi-linear energy adjustment with load changes, so that the system always maintains the highest operating efficiency. The annual operating costs are low. The system does not require a dedicated computer room, so it can release the effective space of the building and realize its economic value.



Projects Solutions

- Solution for Shopping Mall : Air-cooled Water Chiller + Air handling Unit + Fresh Air Unit + Variable Air Volume Unit

System Introduction:

According to the characteristics of large flow of people and high demand for air volume in commercial places, the system adopts variable air volume units with large air volume and air handling unit and modular units configuration, which can realize non-stop maintenance; eliminates the need for cooling water system, and has a small initial investment; dual use of cooling and heating , No need to configure the heating system separately; in addition to ensuring the reliable operation of the system, intelligent control realizes quasi-linear energy adjustment with load changes. It can be easily switched to the mode of fresh air during the transition season, so that the system always maintains the highest operating efficiency. The annual operating costs are low. The system does not require a dedicated computer room, so it can release the effective space of the building and realize its economic value.



Projects Solutions

- Solution for Amusement Building : Air-cooled Water Chiller + FCU + AHU + Fresh Air Unit + Heat Pump Water Heater

System Introduction:

In addition to reliably ensuring the use of air conditioners, the system can also guarantee 24 hours of hot water supply for 365 days; the cooling water system is omitted, and the initial investment is small; the heating and cooling systems are dual-purpose, without the need for additional heating systems; the modular units configuration can be realized. The system capacity can also be increased at any time according to the operating conditions if the maintenance is disabled; intelligent control realizes quasi-linear energy adjustment with load changes. The system does not require a dedicated computer room, so it can release the effective space of the building and realize its economic value.



— Delivery & Packaging —

- 100% test before delivering products & services.
- Products catalogue, installation & operation manual will be sent together.
- Tracking number will be sent to customer as soon as we ship the products.
- Item shipped in 35~45 working days against payment depends on the quantity.
- Four steps of packages, plastic film, foam, carton and plywood for stable transportation.
- Ocean shipping, railway shipment and air transportation are acceptable according to customer demand.

— You May Like —



Air Cooled Water Chiller



Fan Coil Unit



Variable Air Volume Unit



Air Handling Unit



Insulation materials



Thermostat

— Technical Support —

Withair's rich experienced engineering team provides good support for any questions concerning the products and installation before, during and after products are sold.

● **Before Selling**

Set up customers file and arrange professional sales engineers to introduce company products and services to customers in details. If customers are interested in our products, we will send professional technicians to survey the installation environment and provide solutions according to different customers' requirements.

● **During Selling**

Machine installed and tested by QA engineers. Ensure all the products we provide are qualified and new. Construct and install the heat pump according to national relevant policies strictly and ensure high quality delivery on time. Test and debug the units strictly to ensure the safety and stability. During the delivery, provide comprehensive and professional technical training on instructions and maintenance to customers.

● **After Selling**

We promise to offer free consulting call in 7×24 hours mode to solve the problems found in practice. The service number: +8616651688268. Withair offers Five-year guarantee. Within 18 months since the delivery date, if the product has any failure under normal usage, Withair will provide free assembly parts. After the expiration of the warranty period, we will continue to provide lifelong maintenance services, with just a small amount of charges.

—— **Physical Design, Online Production, Test, Package, Shipment and Installation** ——

With perfect manufacturing process, Withair care every detail on what you need !

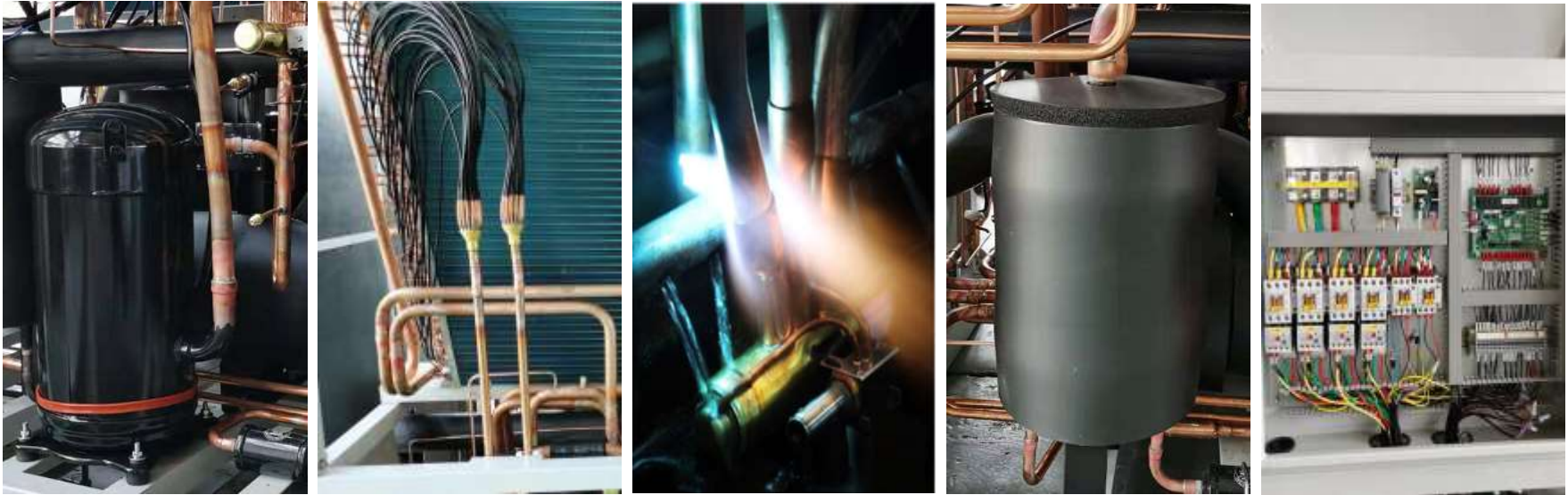

- **Super Low Noise:** Equipped strong pads for compressor to avoid vibration
- **Anti-corrosion:** Aluminum edging
- **Excellent Welding Guarantee No Leakage:** Four-way valve welding protection
- **Energy Saving:** 30mm thickness for insulation to prevent energy lost
- **Reliability of the Connection:** Adopt automatic stamping machine

— Physical Design, Online Production, Test, Package, Shipment and Installation —



—— Physical Design, Online Production, Test, Package, Shipment and Installation ——



— Physical Design, Online Production, Test, Package, Shipment and Installation —



—— Physical Design, Online Production, Test, Package, Shipment and Installation ——



— Physical Design, Online Production, Test, Package, Shipment and Installation —



— Physical Design, Online Production, Test, Package, Shipment and Installation —



—— Physical Design, Online Production, Test, Package, Shipment and Installation ——



—— Physical Design, Online Production, Test, Package, Shipment and Installation ——



— Some Certificates —



Withair®, Your Reliable Partner For Successful Business !



The technical data in this document are not binding.

Withair reserves the right to introduce at any time whatever modifications deemed necessary for improving the product.

Withair Group (China) Limited

Withair (Nanjing) Industries Co.,Ltd

Factory A: No.6 Lukou Chuangzhi Industrial Park, Nanjing,China,211113

Factory B: No.9 Dongshan Bridge Industrial Park, Nanjing,China,211153

Tel: +86 25 86696286 & 16651688268 Mob: +86 139 159 28183(WhatsApp)

E-mail: info@withair.cn & withairgroup@gmail.com

Website: www.withair.cn



Mobile Web



Official Wechat